

accessorize

EganWall

EGAN

Indoff

www.ahutton.com

(860)632-2026

Additional Instructions for Accessorizing your EganWall

- Trimming your EganWall
- Installing EganSystem Track and Vertical Trim
- Adding Reversible Boards and Pen Tray

Trimming Your New EganWall

Examine goods to assure quantity and quality is as ordered.

Tools Required:

- Tape measure
- 4 foot level
- Hacksaw
- Miter box
- Electric drill
- Phillips screw driver
- Speed bore drill with 1/2" and 9/16" bits
- Sharp pencil

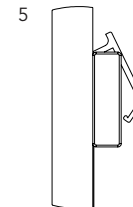
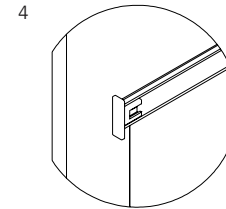
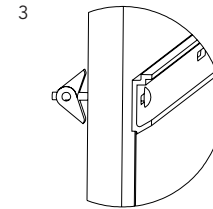
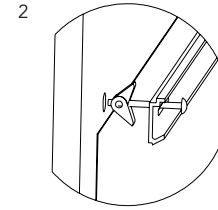
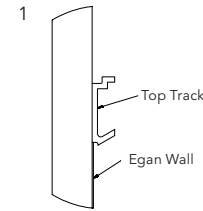

Installing EganSystem Track

Note: If vertical trim kit is to be applied, install the track with a 3/4" overhang on both ends. If necessary, cut the aluminum track and facing to required length with a hacksaw and miter box.

- 1**

 - Position the track so that the bottom edge is leveled 1/8" above the top edge of the EganWall, with a 3/4" overhang on the left edge if you're installing vertical trim. Do not overlap the EganWall.
 - Measure 4' from the left edge point to mark the mid-point of the 8' track on the wall with a pencil. Then mark all mounting locations on the wall.
 - Mark the 4' mid-point on the track.
- 2**

 - Drill 9/16" holes in the wall at the mounting locations.
 - Fit the toggle bolts through the track and drywall.
- 3**

 - Pull the track out as you tighten to engage the toggle bolt and keep it from spinning.
 - Check the level before fully tightening.
- 4**

 - Install the end caps in each end and fasten with supplied screws.
- 5**

 - Beginning on the left with the short segment, snap the plastic extrusion into place.

If installing track along the bottom, position 1/8" below EganWall and repeat installation instructions.

Installing Vertical Trim

Note: The vertical base trim has holes every 12". Please use at least 3 fasteners per segment. The vertical trim extrusion ships in 60" lengths. These will need to be cut to size for final installation.

1

- Position the track so that the leveled vertical edge leaves a 1/8" gap from the edge of the EganWall, and a 1/2" gap from the top track. Do not overlap the EganWall.

2

- Measure 1" from the top of the bottom track to mark the length of the vertical trim with your pencil.
- Mark all mounting locations on the wall.
- If necessary, cut the trim to fit.

3

- Attach trim to wall using appropriate wall fasteners.

4.

- Position the extrusion flush to the top of the vertical track.
- Mark the cut length to the length of the track.
- Cut the extrusion to length with a hacksaw.
- Place the extrusion cap on top of the track.
- Starting from the top, position the extrusion flush with the vertical track, and snap the extrusion firmly into place.

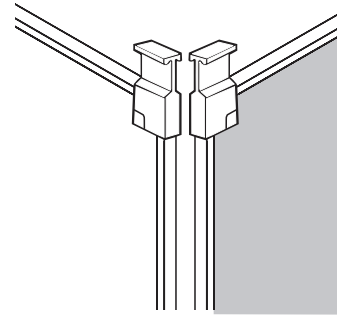
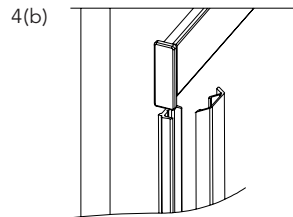
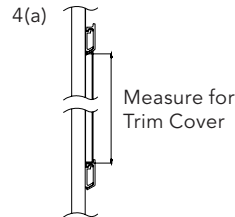
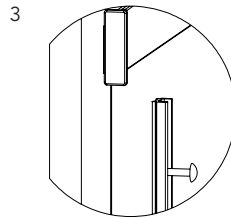
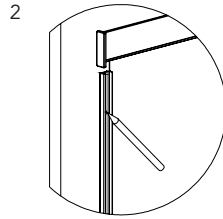
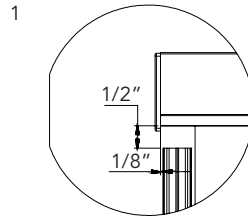

Indoff
www.ahutton.com
(860)632-2026

Add EganWall 202 Markerboards and Tackboards

EganSystem track supports EganWall Markerboards and Tackboards to complete your communication solution.

202 Markerboards offer the same visual versatility as the EganWall, and are also guaranteed-to-clean.

Tackboards are standard in EganFabric, a stable polyester fabric, in a neutral color that complements the full range of standard and Custom Color finish choices.

Egan has a synergy program with Maharan Fabrics to offer thousands of optional tackable fabrics. C.O.M. (Customer's Own Material) requirements may be coordinated through Customer Service. A sample is required for approval prior to order acceptance.

Adding Shelves and Trays to your EganWall.

The addition of an EganSystem Track to the bottom of your EganWall frames the entire presentation wall, creating a distinctive design statement.

Position a Reference Shelf at any location along the lower track to hold presentation tools and reference material.

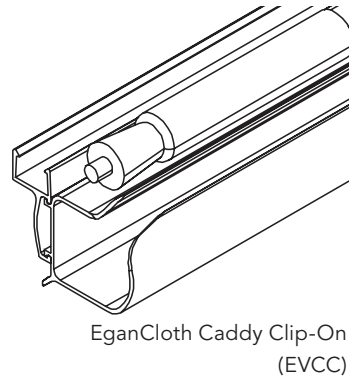
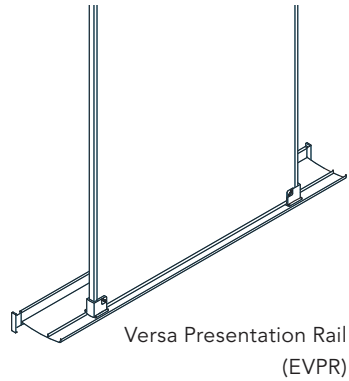
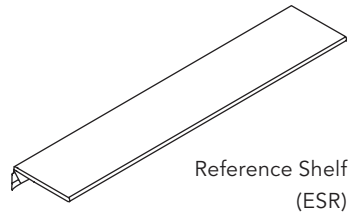

Continued Care of EganWall - EganCloth

Made with a revolutionary microfiber fabric that attracts dry-erase dust like a magnet, the surface structure of the EganCloth contains 90,000 microfibers per square inch. These "micro-hooks" grab, lift and hold dust and grime, eliminating messy dry-erase residue, ghosting, and reducing the need for cleaning solutions. It's hypo-allergenic, too. The EganCloth will not scratch whiteboard surfaces or paint finishes.

The EganCloth works best dry. Hold it any way that feels comfortable, and wipe the board. It's that simple. As areas of the cloth get soiled, simply fold and refold to expose clean fabric. Even though you may see dry-erase dust on the cloth, don't worry, it will not transfer to your hands or clothing. The cloth traps dry-erase dust – removes it from the whiteboard surface – keeping residue off your hands, clothing, walls, and carpets, too.

Washable EganCloth: When the cloth gets dirty, hand or machine wash the EganCloth in warm, soapy water. Do not use fabric softener. The EganCloth can be laundered literally hundreds of times and still retain its original cleaning properties. Wash separately (microfibers will catch lint in the wash water, which could reduce the effectiveness of the cloth). Dry on a regular tumble cycle.

Indoff

www.ahutton.com

(860)632-2026