

PLUS

Copyboard with Memory Function

M-11S/M-11W

User's Manual

Thank you for your purchase of the PLUS Copyboard.
Please read this User's Manual carefully before use to take full advantage of the functions of this product. After you have finished reading the manual, please keep it for future reference.

This User's Manual covers both models M-11S and M-11W.

The copyboard is available in a standard size (model M-11S) and a wide size (model M-11W).

A printer and stand may be available as options depending on the product you purchase.

Descriptions and diagrams refer to model M-11S.

*** Model names will be given where model-specific functions or operations are concerned.**

Trademarks

- Microsoft and Windows are registered trademarks or trademarks in the United States and other countries of the Microsoft Corporation.
- Adobe and Adobe Acrobat Reader are trademarks of Adobe Systems Incorporated.

The trademarks of the various companies and the product trademarks, even when not written down, will be given due respect. Product names and company names appearing in this manual are registered trademarks or trademarks of the respective companies.

- (1) The contents of this manual may not be reprinted in part or whole without permission.
- (2) The contents of this manual are subject to change without notice.
- (3) Great care has been taken in the creation of this manual; however, should any questionable points, errors, or omissions be apparent, please contact us.
- (4) Notwithstanding Section (3), this company will not be responsible for any claims of loss or profit or other matters deemed to be the result of using this unit.
- (5) The use of a printer as the peripheral device of the PLUS Copyboard is taken to be a prerequisite; therefore, operation will not be guaranteed when the Copyboard is used with a direct connection to a personal computer.
- (6) Manuals with incorrect collating or missing pages will be replaced.

Table of Contents

Features	E-4
Important Safety Information	E-5
Package Contents	E-8
Names of the Parts	E-9
Front	E-9
Rear.....	E-10
Control Panel	E-11
Operation Steps	E-12
AC Power Adapter Connections	E-13
Setting the Time	E-14
Printing	E-16
Basic Printing Operation	E-16
Selecting the printing density	E-17
Making additional copies	E-17
Cancellation of the print operation in progress	E-18
Printing in the same ratio as the sheet surface (Model M-11).....	E-18
Moving the sheet surface manually	E-18
Using USB Memory	E-19
USB Memory Storage Procedure.....	E-19
Saving Image Files to a Personal Computer, and Deleting Image Files.....	E-21
Printer Operation Guide	E-23
Printer Set Up.....	E-23
Supplied Software Setup Guide	E-24
Software Contents and Overview	E-24
Operating Environment.....	E-24
Installing the USB driver.....	E-25
Acquiring images of the copyboard directly by the computer.....	E-27
Using the Setup Utility.....	E-28
Disconnecting USB Connections with the Main Unit.....	E-29
Uninstalling the software	E-29
Meaning of Error Messages	E-30
Troubleshooting	E-31
Specifications	E-32
Appendix	E-33
Connections between copyboard and printer	E-33
Changing the Height of the Unit	E-34

Meaning of the Terms Used in this Manual

- USB memory: refers to USB flash memory.
- USB memory storage: means the saving of blackboard data using MEMORY (i.e., the USB port) of the operation panel. (The Copyboard has 3 USB ports.)
- Internal memory: indicates a temporary saving location of the image that has been read.
- “copy”: Both “print” and “USB memory saving” mean to “copy.”
- “Sheet surface”: refer to the drawing portion.
- “Scroll” or “move”: indicates feeding of the sheet.

Features

The Copyboard is a business machine, a whiteboard having an added copying function. It is also called an electronic blackboard. This is a very easy-to-use product equipped with motorized sheet feeding that enables copying from a desired position as well as manual sheet movement, and an easy-to-clean pen tray among other features.

The Copyboard comes in “real” board sizes of 1300 (W) × 920 mm (H) (and 1800 (W) × 920 mm (H) for Model M-11W).

Now you can write down and capture a streaming flow of ideas without missing any.



Stylish and Functional Design

Retaining the design of the existing M-10 Series, the color has been changed to harmonize with the latest office environments.

The operation panel and USB ports have been arranged at the right side to combine a clean-cut design and ease of use.

The height of the main unit can be adjusted up and down 3 levels from the standard position. Wall mounting is also permitted.



Regular Paper Can be Written on and Kept as a Record

A press of the “Print” button on the operation panel quickly prints what has been hand written on the sheet surface to regular A4 size paper.

By mitigating the need to take notes, the participants of the meeting can concentrate on the agenda.

The paper printout can be written on directly and one’s seal can also be affixed which is convenient if it is to be kept as a record of the meeting, or circulated. The printer can continuously print a maximum of 20 sheets.



One Button Saves the Sheet Surface Image in USB Memory

Inserting a USB memory device into the lower portion of the operation panel and pressing the “Save” button on the operation panel allows what has been written on the sheet surface to be saved in USB memory as an image file.

This function permits a digital record to be acquired with only the use of a USB memory device, without even connecting a personal computer and USB cable.



The Sheet Surface Image Can also Be Imported Directly to a Personal Computer

Connecting the Copyboard to a personal computer using a USB cable allows one-screen portion of information to be directly imported to the personal computer as a digital file.



Maintenance-free, Low Power Consumption

RGB, 3-primary-color LEDs are used as the reading light source which means that there is no need to replace a fluorescent tube as with copyboards up until now. In addition, unlike fluorescent tubes, LEDs need only be lit when reading the sheet surface which is reflected in low power consumption.



Other Features

• Switching between 256 Colors and Black & White

Pressing the color button of the operation panel permits the selection of the vivid 256-color setting when printing, reading digital data, and saving, or black & white which permits economical and speedy printing.

• Density adjustment

A density switching function allows clear copies to be made even with fine writing.

• Digital using the PNG format

The copyboard supports the PNG format, an international image format.

The PNG format can be opened with Internet Explorer 6.0 or above, or with a Web browser that supports PNG file access.

Double clicking on a file from the personal computer permits the image to be displayed without paying attention to software so that attaching the image files to email directed to participants of a meeting, and placing the image files on a web site for intranet use are simple matters.

Image files can be shared and saved even from a remote location.

Important Safety Information

WARNING

The unit's rear panel should never be opened by anyone other than a qualified serviceperson. Contact your store of purchase to request internal inspection, adjustment, repair, and cleaning.



CAUTION

Continued use of the unit under abnormal conditions (when the unit is emitting smoke, unusual odors or sounds) could lead to fire or electric shocks.

Turn off the unit's power immediately, then unplug the AC power adapter from the power outlet.

Check that no more smoke, etc., is being emitted, then contact a sales outlet for repairs.

Repairing the unit yourself is dangerous. Never attempt to do so.

WARNING

This is a FCC class A product. In a home environment this product may cause radio interference in which case the user may be required to take adequate measures.

WARNING

This product is not for use in Computer Rooms. The description "Computer Rooms" refers to areas where an abundance of computer control equipment (such as high output servers) is being used.

It does NOT refer to environments such as offices or classrooms where there are simply PC's being used.



This symbol warns the user that uninsulated voltage within the unit may have sufficient magnitude to cause electric shock. Therefore, it is dangerous to make any kind of contact with any part inside of this unit.



This symbol alerts the user that important literature concerning the operation and maintenance of this unit has been included. Therefore, it should be read carefully in order to avoid any problems.



SAFETY PRECAUTIONS

Heeding the safety precautions below will lengthen the product's service life and prevent fires, electric shocks and injury. Read these safety precautions carefully and be sure to heed them.

Handling the AC power adapter

- Do not connect any AC adapter other than the dedicated one to the unit. Doing so could result in fire or other accidents.
- Do not use with voltages other than the voltage indicated. Doing so could result in fire or electric shock.
- Do not let the AC power adapter get wet. Doing so could result in fire or electric shock.
- Do not subject the AC power adapter to shocks. Doing so could result in fire or electric shock.

Handling the AC power adapter's cord and plug

- Damaging the power cord could lead to fire or electric shock.
 - When installing, do not squeeze the power cord between the product and a wall, rack, etc.
 - Do not modify or damage the power cord.
 - Do not place heavy objects on the power cord or pull strongly on it.
 - Do not place the power cord near heating appliances or otherwise heat it.
 - When unplugging the power cord, always do so by pulling on the plug, not the cord.
- If the power cord should be damaged, ask your store of purchase to replace it.
- If there is dust or metal objects on or near the power plug's blades, unplug the power cord then wipe the blade area clean using a dry cloth. Continued use without cleaning the plug could lead to fire or electric shock.
- Do not plug in or unplug the power cord with wet hands. Doing so could lead to electric shock.
- When moving the unit, turn off the power and be sure to unplug the power cord from the AC outlet first. Moving the unit with the power cord plugged in could damage the cord, leading to fire or electric shock.
- Connect the power plug securely to the AC outlet, pressing the blades in to the hilt. Uncomplete plugging could cause heating or attract dust, leading to fire. In addition, touching the plug's blades could cause electric shock.

Important Safety Information

Reflected Light from the Sheet Surface

The sheet surface of the main unit has a white glaze and when a projector or other optical equipment is projected, the reflected light could result in eye fatigue or other symptoms, so please be careful.

Also note that the light emitted from laser pointers can be linked to unexpected accidents, so please refrain from using them.

Do not use the included CD-ROM in a player designed for audio CDs.

- Never use the included CD-ROM in a player designed for audio CDs. Doing so could produce loud noises that could impair your hearing. These noises can also damage your speakers.

Installation

- When mounting on a wall, be sure to check first that the wall surface is strong enough to support the total weight of the main unit, mount fittings and printer over a long period of time (including during earthquakes). If the wall is not strong enough, reinforce it before mounting the unit.
- Getting water on or inside the unit etc., could lead to fire or electric shock. Be particularly careful when using the unit near a window when it is raining or snowing and when using it near the shore of the ocean and lakes.
- Do not set the unit in hot places exposed to direct sunlight or in places exposed to wind coming directly from an air conditioner.
Do not set the unit in places exposed to soot or humidity (on kitchen counters, near humidifiers, etc.).
- When the power plug will be unplugged from the power outlet, please place the Copyboard near the power outlet so that it may be reached easily.

Preventing Tipping (for stand type units)

To prevent tipping, heed the instructions below. Tipping could lead to personal injury or damage the unit.

- Use the unit on a flat floor.
- Be sure to attach the supplied stabilizers to the stand, and lock the stoppers of the casters. Failing to do so could result in the unit tipping and could lead to personal injury.
- Do not lean against the unit or apply excess force to the top of the unit.

Cautions on Usage

- Take care that the unit does not get wet and that water does not get inside. Do not place objects containing chemicals, water or other liquids (vases, potted plants, glasses, cosmetics, etc.) on top of the unit. The liquid could spill and get inside the unit, leading to fire or electric shock.
- When lifting the unit to adjust the height, etc., the unit should be lifted by at least two persons to prevent it from tipping and causing personal injury.
- Do not move the sheet with paper or other objects attached to it. Doing so could cause damage.
- Do not wipe the unit or sheet with thinner, benzene, alcohol or other such products. Doing so could cause discoloration or damage the sheet.
- Only use markers designed exclusively for this product. Using other markers could damage the sheet. Also note that it may not be possible to erase the ink of other markers.
- When moving the (stand type) unit, remove the stabilizers and release the caster locks. Hold the sides of the main unit and move it gently. Avoid shocks.
- When not using for long periods of time, for safety be sure to unplug the AC power adapter from the power outlet.
- Make entries within the effective reading size. Portions that are drawn outside of this range might not be printed or copied when saving to USB memory or personal computer.

Important Safety Information

Cleaning

- If the sheet is dirty, wipe it clean using a damp, thoroughly wrung out cloth. For tough dirt, apply some diluted neutral detergent to a cloth, wipe off the dirt, then wipe again to remove any detergent.
Wait until the sheet is completely dry before using it.
- Do not wipe the copyboard or sheet with thinner, benzene, alcohol, etc. Doing so could cause discoloration or damage the sheet.
- Wipe of any marks from markers on the pen tray or the frame cover using a damp, thoroughly wrung out cloth.
For cleaning of the printer, please refer to the printer's operating instructions.

Handling the CD-ROM

- Do not touch the surface on which nothing is printed (the surface on which the data is recorded). If this surface is dirty the data will not be read properly.
Also, do not stick paper, stickers, etc., on the CD-ROM.
- Do not leave for long periods of time in places exposed to direct sunlight or near heating appliances, and do not drop or bend the CD-ROM. The disc may get warped, making it impossible to read the data.

USB Memory

- The USB memory formats supported by the copyboard are FAT 12/16, and FAT 32. There are also types of USB memory that cannot be used by this unit. Check the PLUS Vision web site for types of USB memory that have been verified to work with the copyboard.
- As a provision against the unlikely event of a problem with or disappearance of the data saved in the USB memory, we recommend that the data be regularly saved to other media.
- PLUS Vision will not be responsible for the loss of content stored in the internal memory of this unit (i.e., images that have been read), or in USB memory.

USB Cables

Use USB shielded cable that has USB-IF logo compliance. Do not use this unit with a connection to a USB hub. The unit may not operate properly.

Package Contents

The package contents are as described below. Please check before use.

Copyboard, main unit [1]

See "Assembly and Setup Manual" for information about the assembly parts of the copyboard.

Printer* [1]

Please see the instruction manual of the printer for information about the printer accessories.

Stand* [1]

*The printer and stand may be sold separately.

Copyboard Accessories

• Special markers

(One each of black, red, blue, and green)

Use these markers to draw on the sheet surface.

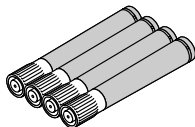

• Special eraser [1]

Use this to erase the drawing.

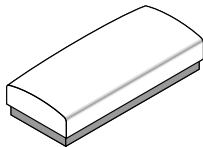

• AC power adapter (with power cord) [1]

This is the power adapter for supplying power to the copyboard (See Page E-12).

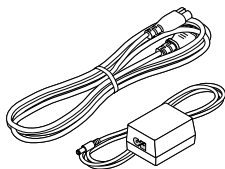

• USB cable (type B ↔ type A) [1]

Use this cable to connect the copyboard with a computer (See Page E-33).

(The cable can be used for a personal computer connection if it is not used with the printer. See Page E-25.)

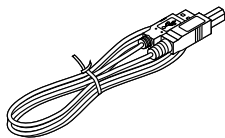

• Cushions [2 pcs.]

These cushions are used to absorb the shake of printer tray in case wall mounting. (See the Assembly and Setup Manual.)

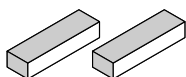

• Wall mount brackets [1 set]

These fittings are used to mount the copyboard on a wall (See the Assembly and Setup Manual.).

(The set includes four copyboard brackets and 16 M4 mounting screws.)

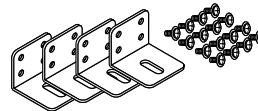

• Printer tray [1 set]

The printer is placed on this tray.

(The set includes one printer tray, brackets for left and right sides, 12 M3 assembly screws, 4 M4 screws, 3 printer guides, and 5 cable clips.)

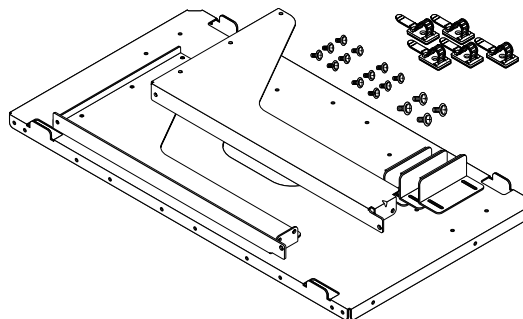

Documents

• User's manual [1]

Includes information about safety precautions and the use of the copyboard.

• CD-ROM [1]

The CD-ROM contains the instruction manual (PDF edition) and the utility software for use with the copyboard.

• Quick Guide [1 set]

The Quick Guide can be hung from a hook. Put the supplied hook to anywhere you want.

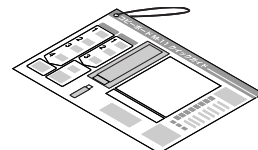

• Recording paper for test printing [5 sheets]

Use this for connection tests when a printer is connected.

• Assembly and Setup Manual

Information covers the setup of the copyboard and the connections with the printer.

Names of the Parts

Front

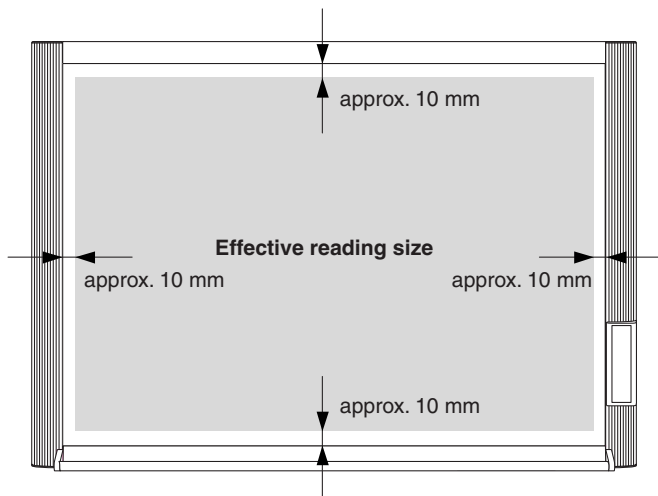
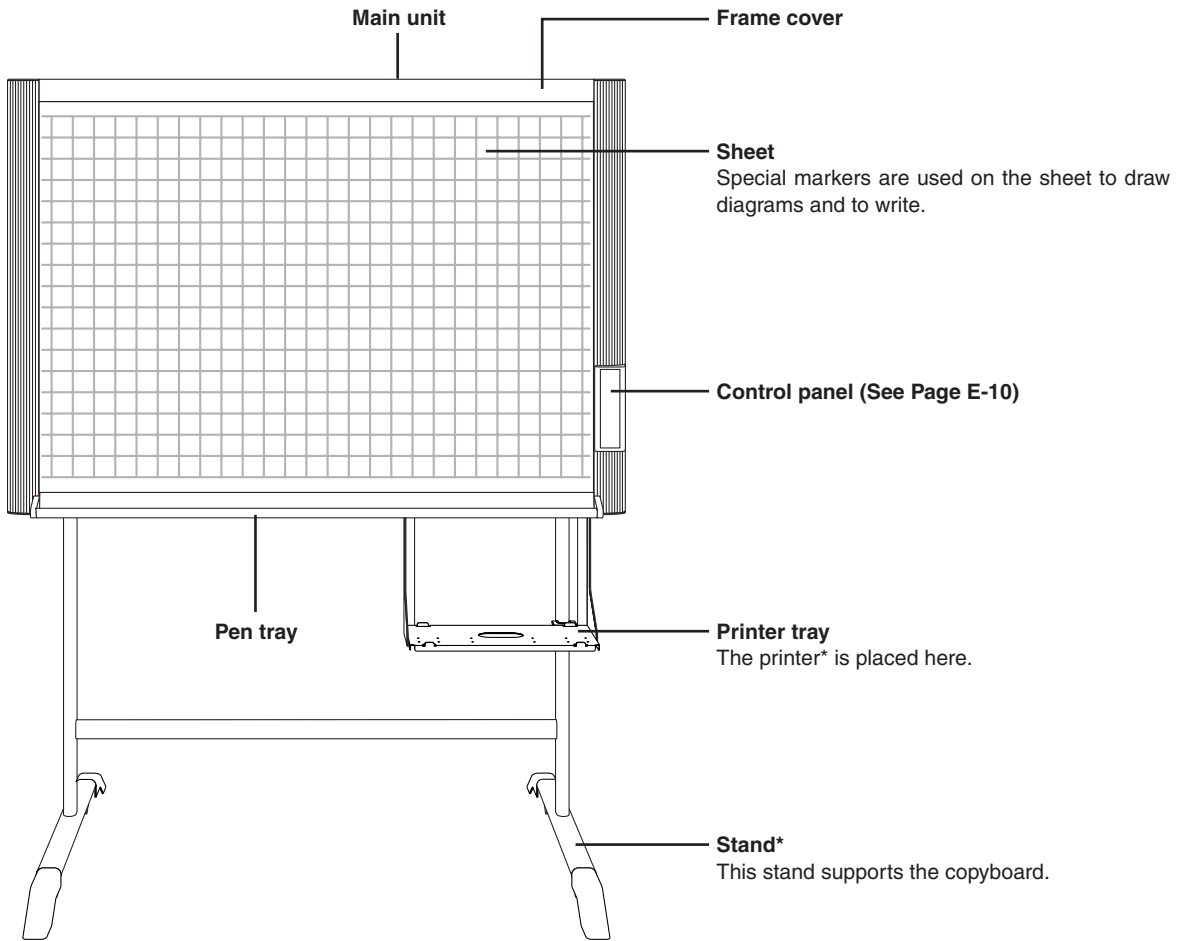

Effective Reading Size

The area that can be copied is the gray area of the diagram.

Note

- It might not be possible to print or copy when storing to USB memory or personal computer any portions that are drawn outside of this range.

*The printer and stand may be sold separately.

Names of the Parts

Rear

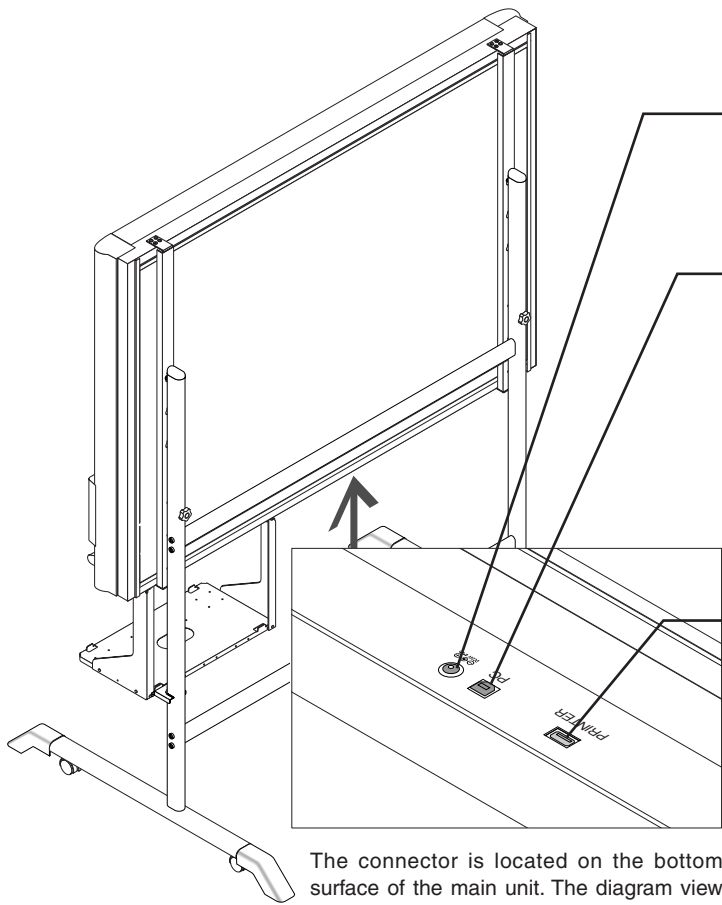

DC input connector

Connect this with the DC plug end of the AC power adapter. (See Page E-13.) (Only connect the supplied AC power adapter; nothing else.)

Personal computer (PC) dedicated USB port (Type B)

Connect this with the USB port (type A) of the PC. (See Page E-25.)
Use this when reading is started from the PC side and image data is transferred directly to the PC, or when setting the operating environment of the copyboard from the PC side. First, install the drivers and software contained on the supplied CD-ROM. (See Page E-24 of the Supplied Software Setup Guide.)

Printer connector

Connect this with the USB connector of the printer (See Page E-33).
(The printer connector is dedicated for use with a printer; use it only with a printer.)

The connector is located on the bottom surface of the main unit. The diagram view is seen from the bottom.

Locking and unlocking the casters of the stand*

Lock the casters with the stopper after setup. To move the unit, remove the stabilizers and release the caster stopper. Press the bottom of the stopper to lock it. Press the top to release it.

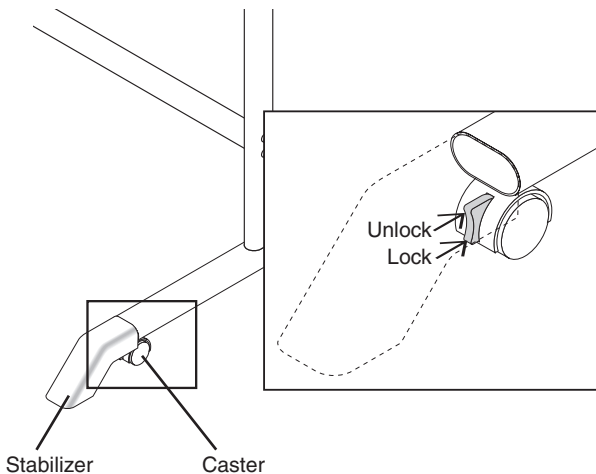

* May be sold separately.



Names of the Parts

Control Panel

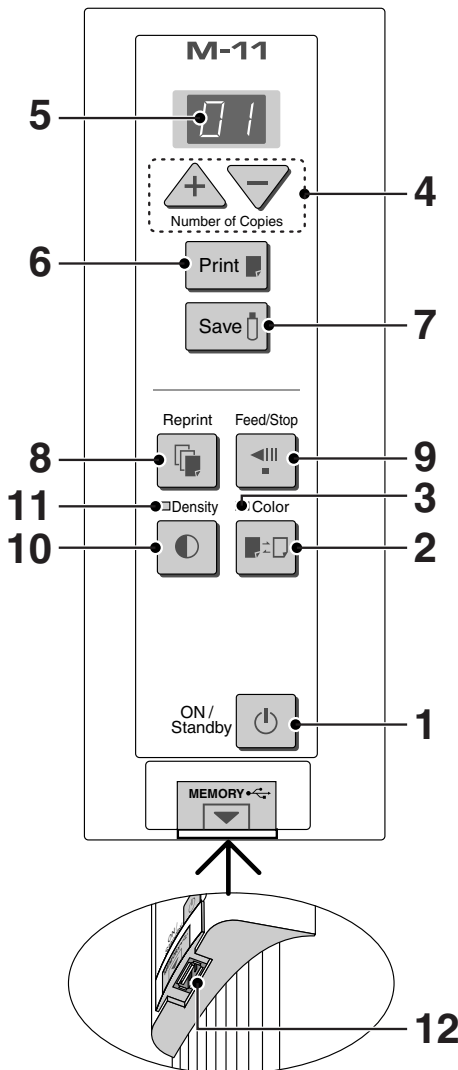
When pressing a button, please press the center area (i.e., the round and protruding portion). Pressing the corner will not work.



1 ON/Standby button

Switches the power of the copyboard on and off. The ON/Standby  button does not synchronize with the main power control of the Copyboard. Pressing the ON/Standby  button in combination with another button permits setting of the current time and the print compression. See pages 14 and 19 for details.

2 Color button

Selects whether to print (or store in memory) in “color” or “black & white”. The COLOR lamp lights when “color” is selected. *When a black & white printer is connected, the printout will be in black & white even when “Color” is selected.

3 Color mode lamp

Lights in green when “color” is selected with the Color  button.

4 + / - buttons (Number of copies)

Pressing the + button or the - button sets the number of copies to be printed (to a maximum of 20 sheets). The number of copies appears in the display window.

5 Display window

This 7-segment LED displays the number of copies to be printed, the USB memory storage operating condition, and error information. Please see Page 30 for details about error information.

6 Print button

Moves a one-screen portion of sheet and reads it, then prints the number of copies displayed in the display window.

7 Save button (USB memory storage)

Moves a one-screen portion of sheet and reads it, then stores the data on a USB memory.

8 Reprint button

Prints the previously printed sheet surface one more time. (The sheet does not move.) The number of copies can be changed, but the density and the color/monochrome selection cannot be changed.

9 Feed/Stop button

Scrolls the sheet one screen portion left, then stops automatically. A press of this button while scrolling will stop the scrolling.

10 Density button

Selects the copying density, either “standard” or “dark”. The Density mode lamp lights when “dark” is selected. This function will be effective at time of printing, USB memory storage, and personal computer storage.



11 Density mode lamp

Lights in green when “dark” is selected with the Density button.

12 Memory button (USB port Type A)

Saves in commercially-available USB memory images that have been read by the copyboard.

Operation Steps

The copyboard uses a CCD image sensor to read the diagrams and text that have been written down with special (4-color) markers, and accumulates the image data in internal memory. Pressing the Print  button prints out the sheet surface image data from the printer, and pressing the Save  button stores the image data to USB memory.

Preparation

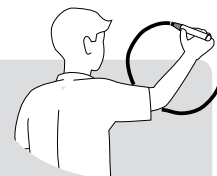

- **Set up the newly purchased copyboard and connect a printer.**
See a separate manual titled “Assembly and Setup Manual.”
- **Connect the supplied AC power adapter. See Page E-13.**
- **Set the time of the newly purchased copyboard. See Page E-14.**



Draw on the Sheet Surface



Please draw with the special markers that have been supplied. To erase, use the supplied special eraser. Please be sure to draw with the special markers. Failure to do so may result in a drawing that cannot be erased or soiling of the sheet. To move the sheet by hand, please see “Moving the Sheet Surface Manually” on Page E-18.

Printing

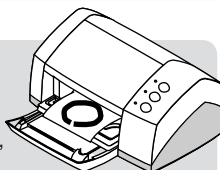
- (1) Set A4 or letter size paper.
- (2) Switch on the printer power.
See “Printer Operation Guide” on Page E-23.
- (3) Press the ON/Standby  button of the copyboard and switch on the power.
- (4) Press the Print  button. The copyboard will move a one-screen portion of sheet, read the image, and start the copy operation*.
See “Printing” on Page E-16.



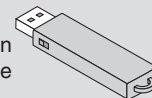

Saving to USB Memory

- (1) Press the ON/Standby  button of the copyboard to switch on the power.
- (2) Insert USB memory into the Memory  port (USB port) of the copyboard.
- (3) Press the Save  button.
See “Using USB Memory” on Page E-19.



When Not Using the Copyboard

- (1) By all means, cleanly erase the drawing from the sheet surface with the special eraser. (Leaving the drawing for a long period will make it harder to erase.)
- (2) Press the ON/Standby  button of the copyboard and switch off the power.
The power cannot be switched off while the USB memory remains installed. (This is a prevention function against forgetting to unplug the USB memory.)
- (3) Switch off the printer power.

* A press of the Save  button while printing is in progress will store the image in USB memory after printing is completed. Likewise, a press of the Print  button while the memory storage operation is in progress will start the printing operation after USB memory storage is completed. This convenience allows both printing and USB memory storage to be performed with a single image reading.

Note

- *The color of the images when printed in color or when saved in USB memory will differ somewhat from the marker colors.*
- *Blurred characters, thin lines, overlapping of markers and other factors can cause colors to differ in places and can also result in portions that cannot be scanned successfully. When “Density” is set to “Deep”, the overall print may be dark and the ruled line may appear on the copy.*
In the case of the combination of Deep and Color Mode, the black ink may be mixed into other color.
- *The built-in memory accumulates the read data that was previously printed or stored in USB memory. This data is erased when the power is switched off with the ON/Standby  button.*

AC Power Adapter Connections

To use the copyboard, connect the supplied AC power adapter.

- 1 **Connect the DC plug of the AC power adapter to the DC power connector of the copyboard.**
- 2 **Connect the AC power cord to the AC power adapter.**
- 3 **Plug the AC power cord into a AC power outlet in a wall.**

The descriptions of this manual pertain to the condition in which the AC power adapter is connected.

When the copyboard is not being used

Disconnect the AC power adapter from the wall outlet.

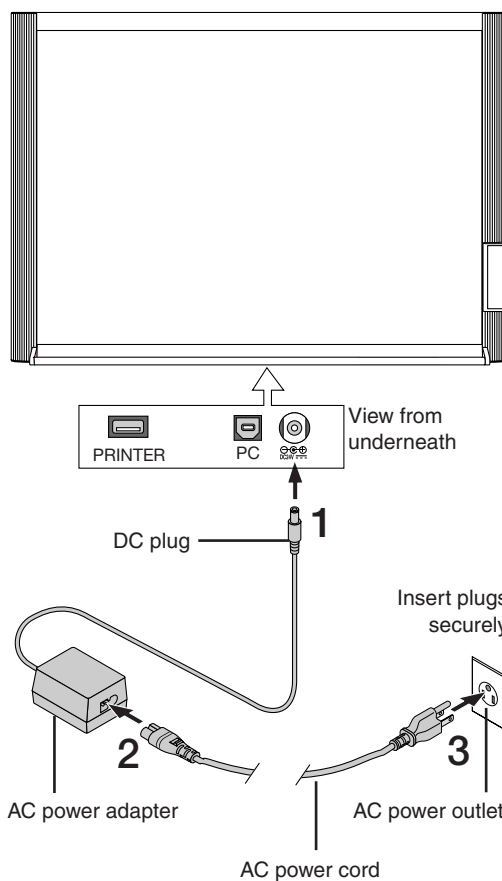

Notice

- When the power plug will be unplugged from the power outlet, please place the Copyboard near the power outlet so that it may be reached easily.

Setting the Time

The clock of the copyboard should be set correctly because the date and time (timestamp) is printed on the printer paper, and it is also recorded in the file information when saving.

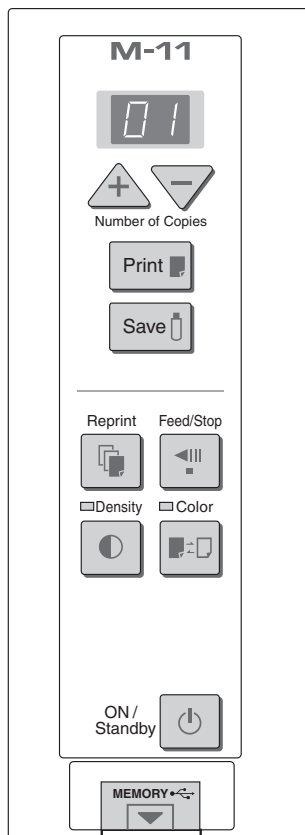

Overview of the Operation

1 Switch to “Time setting”

Press the ON/Standby  button while holding down the Density  button.

2 Display the day and hour setting mode

Each press of the Print  button switches the setting mode as illustrated below.

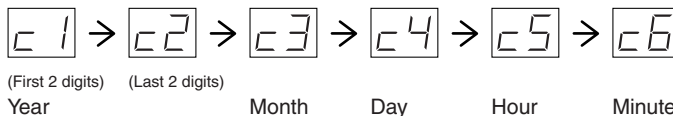

3 Adjust the date and time of the selected setting mode

One press of the + or the – button will enable the settings to be made. Press the + or – button and make the adjustment.

4 Press the Print button to finalize

There is a change to the next setting mode. Perform operation 2, or 3 and 4 to set the current time.

5 Completion

Change over to the minutes setting mode (c6 display) and press the Print  button to complete the “Time setting.”

- Pressing the ON/Standby  button during operations 2 to 4 will cancel the incomplete settings and return to the time prior to starting the settings.

Preparation:

Connect the AC power adapter to the copyboard. See Page E-13.

Example: Set the time to 2:16 pm, November 8, 2006 (2006.11.08 14:16).

1

Press the ON/Standby  button to switch on the power.

The LED of the display window will light and the power will be switched on.

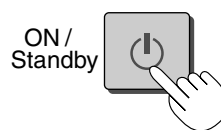

2

Press the ON/Standby  button while holding down the Density  button to switch to “Time setting”

The LED of the display window will light and display “c 1”.

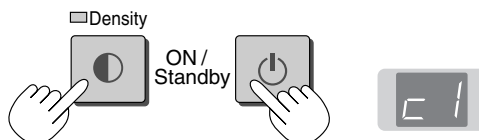

Setting the Time

- 3** Press the + button or the – button, select 20 (the first 2 digits of the year), and press the Print button to finalize.

There will be a change to the “last 2 digits of the year” setting mode (c2 display).

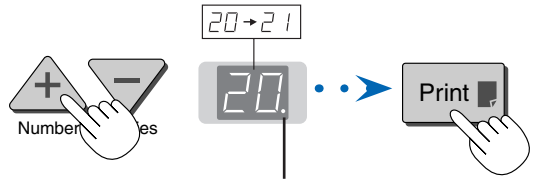

The dot will flash while making settings.

Note

- The factory default setting is 20. Pressing the Print button in this condition will result in a change to the “last 2 digits of the year” setting mode.

- 4** Press the + button or the – button, select 06 (the last 2 digits of the month), and press the Print button to finalize.

There will be a change to the “month” setting mode (c3 display).

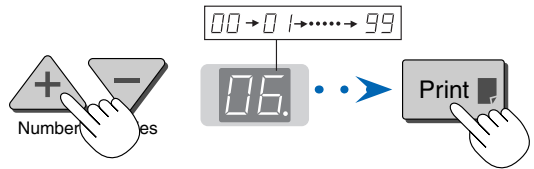

- 5** Press the + button or the – button, select 11 (the month), and press the Print button to finalize.

There will be a change to the “day” setting mode (c4 display).

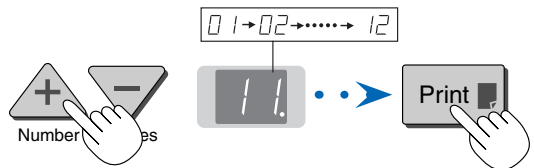

- 6** Press the + button or the – button, select 08 (the day), and press the Print button to finalize.

There will be a change to the “hour” setting mode (c5 display).

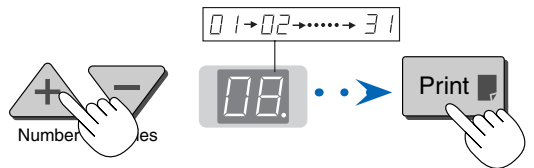

- 7** Press the + button or the – button, select 14 (the hour of the 24-hour display), and press the Print button to finalize.

There will be a change to the “minute” setting mode (c6 display).

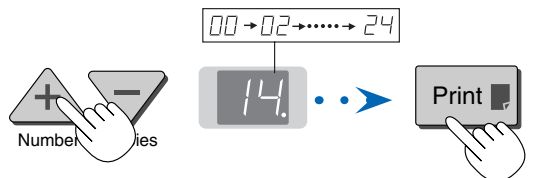

- 8** Press the + button or the – button, select 16 (the minutes), and press the Print button to finalize.

The display will change to being lit steadily, and there will be a return to the display indicating the number of sheets to copy.

This completes the time setting.

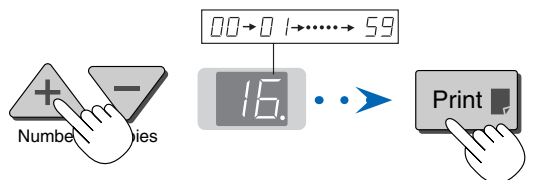

Note

- The factory default print timestamp is set to “enable (print).” If you do not wish to print the timestamp, use the setup utility in the supplied CD-ROM and set to “disable (do not print).” See the “setup guide of the supplied software” on Page E-24.

This function prints the sheet screen of the copyboard on the printer connected to the copyboard.

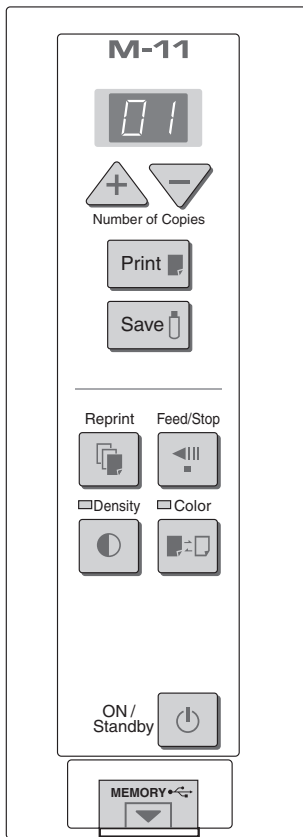

Basic Printing Operation

Preparation:

1. Set A4 or letter size paper in the printer. See Page E-23.
2. Switch on the printer power. See Page E-23.
3. Connect the AC power adapter to the copyboard. See Page E-13.

1 Press the ON/Standby  button and switch on the power.

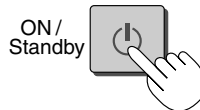

Note

- Press the ON/Standby  button to switch on the power. The LED of the display window will light.

2 When the drawing is on the rear sheet, press the Feed/Stop  button to bring out the desired surface for printing.

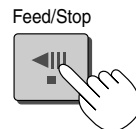

A press of the Feed/Stop  button scrolls the sheet surface one screen portion left and automatically stops it.

To stop the operation part way through, press the Feed/Stop  button again.

Note

- The one-screen that is visible is printable position.
- To make fine adjustments to the sheet surface, when the sheet is stopped, move the sheet slowly by hand. The sheet can be moved either left or right.
- It might not be possible to print from the area that surrounds the sheet surface. Please see "Effective reading size" on Page E-9.

3 Press the Color  button and select Color or Black & White.

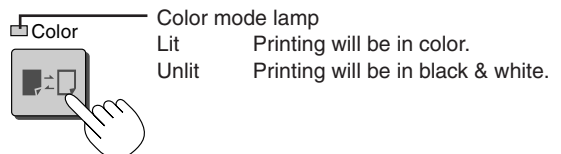

* When the power is first switched on, Color/Black & White is selected automatically.

Note

- When a black and white printer is connected and printing is performed with color selected, the image quality may worsen.

Continued on next page

4

Press the + button or the – button and select the number of copies.

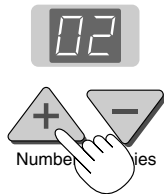

- When the power is switched on, one copy is selected.
- A maximum of 20 copies can be set and the number of copies is displayed in the display window.
- Each press of the + button increases the number of copies (by one) and each press of the – button decreases the number of copies. Press and hold the button to switch continuously.

5

Press the Print button to print.

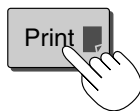

- The reading operation is performed for a one-sheet portion (while the sheet is scrolled) and the printing operation is performed.

Note

- A press of the Feed/Stop button during the reading operation will cause the printing to stop and will result in a partial print.
To move the sheet surface, please press the Feed/Stop button after the scrolling has stopped.
- When a USB memory has been inserted, a press of the Save button during printing will start the USB memory storage operation after printing is completed. (See Page E-18.)
- The one-screen portion is reduced to A4 paper size and printed. In the wide type (M-11W) copyboard, the screen will be reduced to about 75% in the horizontal direction.
To print in the same ratio as the sheet surface, see "Printing in the same ratio as the sheet surface" on Page E-18.
- A flashing "E !" in the display window indicates a print error. See "Meaning of Error Messages" on Page E-30.

6

When the copyboard is not going to be used, press the ON/Standby button and switch off the power.



- Switch off the printer power.

Selecting the printing density

Select this when the density of the print is light.

Press the Density button and select darker or standard.

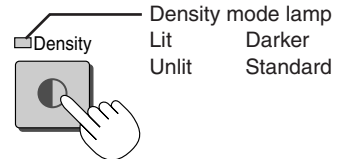

Making additional copies

This will print the copy of the sheet that was scrolled previously one more time.

Press the Reprint button.

This starts the printing of the image data that has accumulated in internal memory.

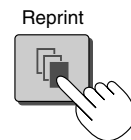

Note

- The sheet is not scrolled when additional copies are made.
- The number of copies can be changed. To do so, make the change before pressing the Reprint button.
- In repeat printing, the color/black & white and density settings will be the same as those of the prior printing.
- When printing or USB memory storage has not been performed since switching on the power, image data will not have accumulated in the internal memory and this operation will not be possible.

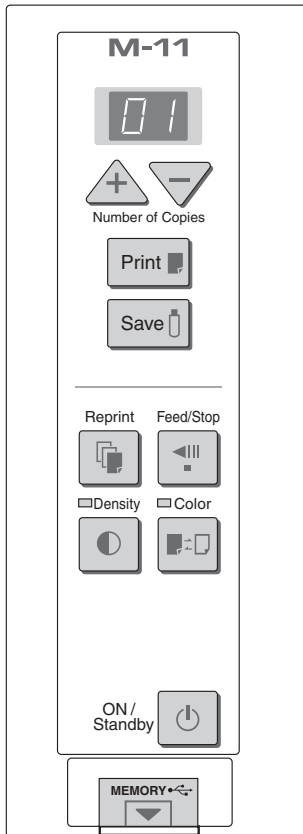

Cancellation of the print operation in progress

During the read operation (when the Print button was pressed)

A press of the Feed/Stop button will stop the sheet during the reading operation and print the image data that has been read up to then. Please wait until the paper has been ejected from the printer.

Feed/Stop

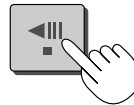

Stopping the printing after the Print button was pressed and the reading completed

Stopping the process when multiple copies are being made when making additional copies (When the Reprint button has been pressed)

Please press the ON/Standby button of the copyboard. Printing will be interrupted in a little while and the paper will be ejected.

Printing in the same ratio as the sheet surface (Model M-11)

Model M-11W is the wide type copyboard which will compress printing in the horizontal direction resulting in crowded printing of the A4 size sheet; for example, a circle will become an ellipse. To print in the same aspect ratio as a drawn diagram, the compression mode will be changed (to suit the paper size according to the sheet surface image). The factory default setting is the horizontal compression mode.

When the power is on, press the ON/Standby button while holding down the Color button.



There will be a change to the "equivalent compression mode." When the mode changes, the Color mode indicator will flash for 5 seconds.

To return to the "horizontal compression mode," perform the same operation.

Moving the sheet surface manually

The sheet can be moved even when the power of the copyboard is switched off.

The sheet can be moved with your hand either in left or right. Please place your hand at the vertical center and move the sheet slowly.

Quick movement can cause damage to the drive mechanism of the copyboard.

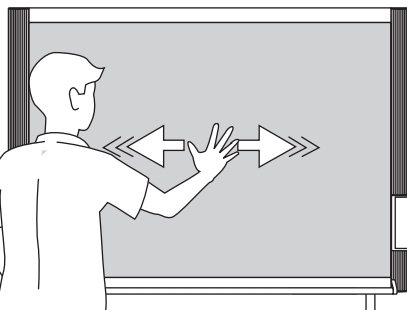

Using USB Memory

The content of what has been drawn on the sheet surface of the copyboard can be saved in USB memory. Later, the saved image can be read into a personal computer and made into a document of the proceedings of the meeting, or affixed to a document.

• What is needed to use the USB memory function

USB memory: Commercially-available product

Personal computer: The connector is a USB port (type A), and the interface supports USB 1.1

Note

- The copyboard supports the USB memory formats of FAT 12/16 and FAT 32.

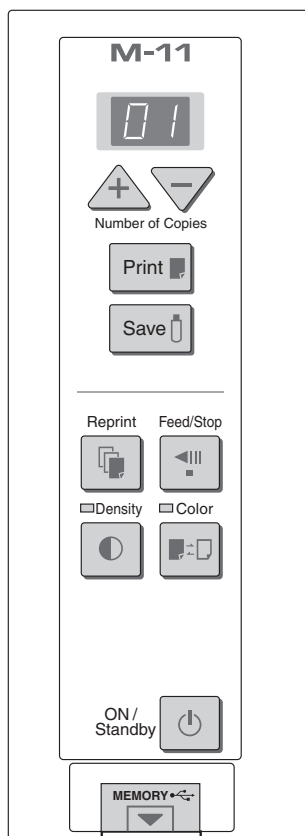

USB Memory Storage Procedure

Preparation:

Connect the AC power adapter to the copyboard. See Page E-12.

- 1 Press the ON/Standby  button and switch on the power.

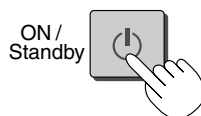

Note

- Press the ON/Standby  button to switch on the power. The LED of the display window will light.

- 2 Insert the USB memory device into the Memory  port (USB port) of the copyboard

- Insert the USB memory device with the access indicator facing toward you.

Notice

- Check the orientation of the USB memory device before inserting it. Forcing it in the reverse orientation will damage the USB port or USB memory device.
- Be careful not to bump into the USB memory device with hand or body while it is mounted. Doing so could damage the USB memory device or USB port.

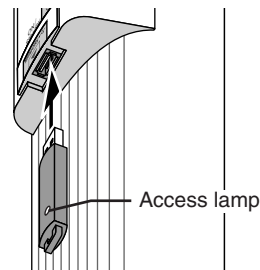

- 3 When the drawing is on the rear sheet, press the Feed/Stop  button to bring out the desired surface for USB memory storage.

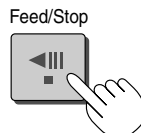

A press of the Feed/Stop  button scrolls the sheet surface one screen portion left and automatically stops it.

To stop the operation part way through, press the Feed/Stop  button again.

Note

- The one screen portion that is viewable will be saved in USB memory.
- To make fine adjustments to the sheet surface, when the sheet is stopped, move the sheet slowly by hand. The sheet can be moved either left or right.
- Saving of the portion located around the sheet surface might not be possible. Please see "Effective reading size" on Page E-9.

Notice

USB Memory Compatibility

- Note that some types of USB memory devices cannot be used. Please see our home page for details.

<http://www.plus-vision.com>

4

Press the Color  button and select Color or Black & White.

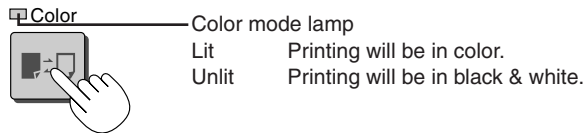

- When the power is first switched on, Color/Black & White is selected automatically.

5

Press the Save  button to store



Flashing indicator “rotates” sequentially during USB memory storage operation.

Display window

- The reading operation is performed for a one-sheet portion (while the sheet is scrolled) and USB memory storage starts after the scrolling completes.







The (5 second) flashing “US” display indicates that the USB memory has not been inserted. Please insert the USB memory and then press the Save  button.



The (5 second) flashing “FL” display indicates that the USB memory is full. The flashing display will stop when the USB memory device is removed. Replace with a USB memory device having sufficient capacity.

See “Meaning of Error Messages” on Page E-30 for other error displays.

Note

- For some USB memories, some time may be required for recognition.
- Do not press the Feed/Stop  button during the reading operation. Doing so will interrupt the USB memory storage and only the image data up to that point will be stored.
To change the sheet surface, press the Feed/Stop  button after stopping the scrolling.
- A press of the Print  button during USB memory storage starts the printing after storage is completed.
- When the wide type (M-11W) copyboard has been adjusted to the paper size in the horizontal direction, the image will be compressed to about 75%.
- The date and time of the saved file will reflect the copyboard time setting. See “Setting the Time” on Page E-14.
- If there is not enough space, the memory card is judged to be full from the start. If the memory card runs out of space while a file is being saved, “FL” is displayed at that point. Delete data, set the sheet surface back to the original status, then press the Save  button again.

Removing the USB memory device

Check that the rotating flashing indicators of the display window have changed to being lit steadily, then pull the USB memory device straight out.

Notice

- Do not unplug the USB memory device during the USB memory storage operation (i.e., during the rotating, flashing display in the display window), or while the access indicator of the USB memory device is flashing because data will be destroyed.

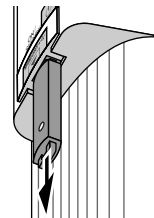

6

When the copyboard is not going to be used, press the ON/Standby  button and switch off the power.



Note

- “USB” letters appearing at one-second intervals in a moving display in the display window indicate that a USB memory device is mounted. Unplugging the USB memory device will switch off the power. (A function that serves as a reminder to unplug the USB memory device)

Using USB Memory

Saving Image Files to a Personal Computer, and Deleting Image Files

Examples of operations follow for saving the image files in the USB memory device to the hard disk of the personal computer, and for deleting the folder when the USB memory capacity is full. (There are various methods that can be used for saving and deleting including the use of Explorer.) See the instruction manual of your personal computer or the software that you are using for information about using a personal computer.

The folder name of the copyboard inside USB memory is M-11. Image files are stored in this folder. Image file names are stored as PV-xxxxxx.png (a PNG file) and PV-xxxxxx.htm (an HTML file). "xxxxxx" stands for the date and number (e.g., PV-06110801.png, PV-06110801.htm).

Notice

To obtain a display and printing that matches the screen size, open the HTML file in a browser and use the browser.

Note

The HTML file and PNG file are associated; therefore, use them as a pair when moving or copying to a separate folder.

1

Plug the USB memory device into a USB port of the personal computer

When connecting to the personal computer for the first time, the installation of a USB driver is required. Follow the instructions manual of the USB memory device that you are using.

- Usually, with Windows 2000/XP the standard driver is installed automatically and is identified as "Removable disk" in "My Computer."

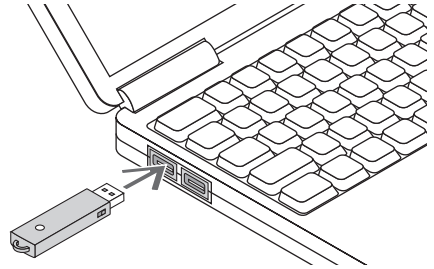

2

Saving the image files of a USB memory device to a personal computer

1. Open "My Computer" and from within, open the drive of the connected USB memory device.

The folder named "M-11" is the saved data of the copyboard.

2. Store the "M-11" folder in "My Documents" or another location.

All of the data contained in "M-11" will be stored.

Notice

- These operations may not work properly if several USB devices are connected to the computer and being used simultaneously.
 - If connected to a USB hub, or if connected using an extension cable these operations may not work properly. Connect directly to the computer's USB port.
-

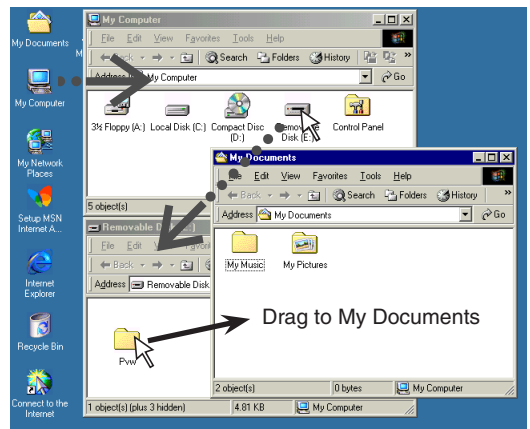

Deleting USB memory image files with the computer

Before deleting important image files, be sure to save them on the computer (as a data backup).

1. Open “My Computer” and then open the drive icon which shows memory card.

The folder named “M-11” contains the memory storage data of the copy-board.

2. Place the “M-11” folder in the “Recycle Bin”, right click on the icon and select “Empty Recycle Bin” from the pull-down menu.

All of the data contained in “M-11” will be deleted.

Even when the entire folder is deleted, a new M-11 folder will be created automatically when USB memory is used again with the copyboard.

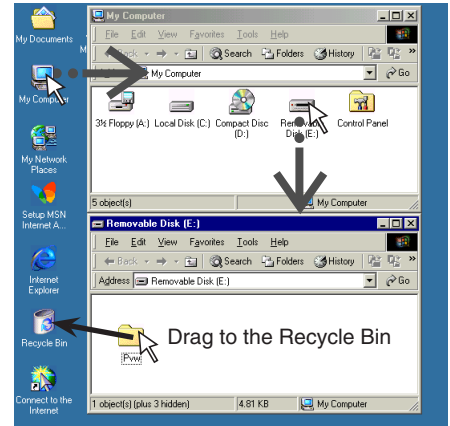

3

Disconnect the USB memory

The disconnecting procedure depends on the computer's operating system. For details, refer to the computer's operating instructions or help files.

1. Click the [Hardware Removal] icon that is displayed in the task tray.

Click “Stop USB Mass storage Device - drive (E)”. (The E drive character will differ depending on the personal computer system.)

2. Click [OK] when “The ‘USB Mass storage Device’ device can now safely removed from the System” is displayed.

(When using Windows XP, [OK] does not appear on the message screen. Simply disconnect.)

3. This allows the USB memory device to be unplugged from the computer.

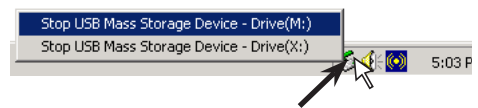

“Remove hardware” icon (example)



Note

- Do not unplug the USB memory device during the USB memory storage operation (i.e., during the rotating, flashing display in the display window), or while the access indicator of the USB memory device is flashing because data will be destroyed.
- The USB drive may not be disconnected properly, for example if the computer is in the process of checking the status of peripherals.

Printer Operation Guide

A printer is used to print the content of what has been drawn on the sheet surface. Depending on the printer, the operation may differ and the names of the parts may be different. Please see your printer instruction manual for details.

Printer Set Up

Please check that the copyboard and the printer have been connected. See Page E-33.

1

Set the paper.

Please use A4 or letter size printer paper.

See your printer instruction manual for details.

- 1) Arrange the paper edges so that they are even.
- 2) Insert paper at the specified position of the paper tray.
- 3) Press the paper guide gently until it touches the paper.

2

Switch on the power.

Press the power switch. The power indicator will light.

This completes the preparation of the printer.

A press of the Print  button on the copyboard operation panel will read the sheet surface portion and start the printing operation.

Notice

- Depending on the printer, the display indicators may flash from the time the power is switched on until printing preparation is completed. When this happens, refer to the printer owner's manual, check that preparation has been completed, and then start the copyboard printing operation.

3

When finished printing...

Switch off the printer power and remove the paper.
Close the paper tray.

Notice

Caution: Do not switch off the printer power while printing.

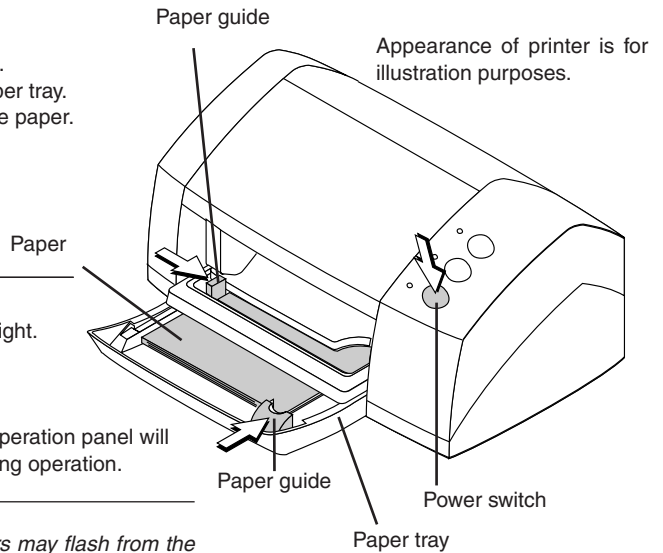

* The printer is an option.

Precautions in the use of printer paper

Please observe the following matters to avoid paper feed problems and paper jamming.

- Please do not use thin paper, thick paper, or handmade paper.
- Do not use paper that has protrusions, recesses, or burrs.
- Do not use paper that is folded, wrinkled, torn, or has cuts in it.
- Do not use embossed paper, paper with a rough surface, or coated paper.
- Do not use paper bearing cellophane tape, seals, or other material.
- Do not print on paper that has already been printed.
- Do not insert paper of differing paper sizes.

Supplied Software Setup Guide

The supplied CD-ROM contains the software and manuals described below. See the Help information of the various software programs for information about how to use the software.

Software Contents and Overview

• USB Driver

This driver software makes the computer recognize the Copyboard as an external device when there is a USB connection. Be sure to install this USB driver when connecting the PC dedicated USB port with the computer.

• TWAIN Driver

This drive is used to acquire the scanned data into a computer as an image.

* This driver may not work on some applications.

* This driver conforms to TWAIN standard (ver. 1.9).

• Setup Utility

This is a utility for customizing the M-11's environmental settings.

• User's Manual

The User's Manual is stored on the CD-ROM in PDF format.

If Acrobat Reader is not installed on the PC, click "Acrobat Reader" on the menu and install it according to the instructions on the screen.

• PLUS Image Viewer

This utility is used to display the images stored in a personal computer or print it out.

• Acrobat Reader

This software is used to view PDF files.

• Browsing the CD-ROM

Explorer running on the personal computer is used to display the contents of the CD-ROM.

• Copyrights and usage conditions

This opens the copyrights, usage conditions, etc.

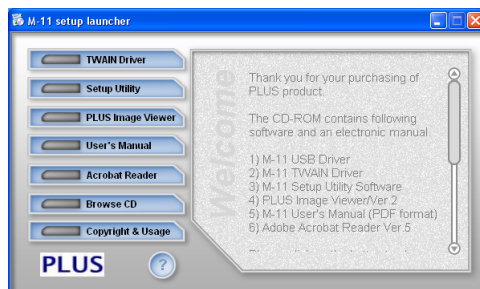

Note

- When installing on Windows 2000, please install the software with "Administrator" authority (i.e., a user having administrator authority).
- When installing on Windows XP, please install the software with "Computer Administrator" authority (account).

Notice

- The help of the PLUS Image Viewer uses the online help system that is used for Microsoft HTML Help.

Operating Environment

Supported OS:	Microsoft Windows 2000 Professional (Service Pack 4 or later)/ XP (HomeEdition / Professional Edition Service Pack 2 or later)
Supported PC:	IBM PC/AT or completely compatible machines that operate the aforementioned OS
CPU:	Pentium II or later
Memory:	Windows 2000 (128 MB or bigger), Windows XP (256 MB or bigger)
Free hard disk space:	40 MB or bigger
Display resolution:	800 × 600 pixels or higher
Peripheral devices:	a CD-ROM /DVD-ROM drive, a standard USB port (USB 1.1 or 2.0)
Web browser:	Internet Explorer 6.0 or later

Notice

- All operations are not guaranteed under the aforementioned operating environment.
- Not compatible with Windows 95, 98SE, Me, NT, 2000 Server or Server 2003.

Supplied Software Setup Guide

Installing the USB driver

When connecting the copyboard's PC dedicated USB port to the USB port of the computer, it is necessary to install the accompanying USB driver to allow the computer to recognize the copyboard as an external device and permit reading and writing.

Once installed on the computer, there will be no need to install it again.

1

Turn on the computer's power and start up Windows.

Logon using an account that has administrator privileges which allows making changes to system settings.

2

Turn on the copyboard's power and connect it to the computer using the USB cable.

Use the supplied (or a commercially available) USB cable to connect the PC dedicated USB port on the bottom of the copyboard with the USB port of the computer.

Note

- Use a USB-IF certified shielded USB cable.
-

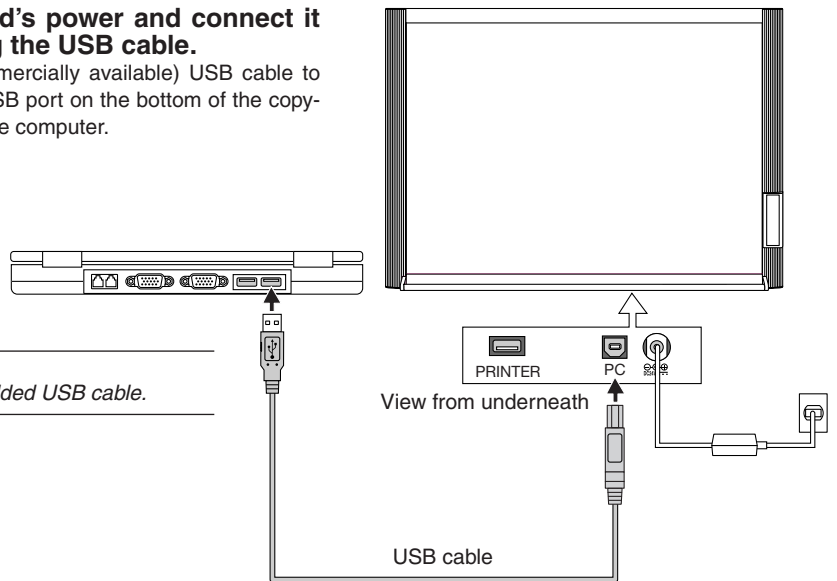

3

When the "New hardware wizard" starts, click the "Next" button.

4

When "M-11 USB Device" is detected, select "Search for a suitable driver for my device (recommended)" (Windows 2000), or "Install from a list or specific location (Advanced)" (Windows XP), then click the "Next" button.

5

Set the included CD-ROM in the CD-ROM drive.

If the setup window appears, click the "x" (close) button to close it.

6

Select only "Specify a location where to search", then click the "Next" button (Windows 2000), or select only "include this location in the search" (Windows XP).

7

Specify “D:\M11USB” (D is the designation of the CD-ROM drive) in the text box and click the “Next” button.

8

Once the driver is found, click the “Next” button.

9

Once installation of the USB compatible device’s driver is complete, click the “End” button.

This completes the installation.

Perform the USB device disconnection procedure at the computer side before disconnecting the USB cable. See “Disconnecting USB Connections with the Main Unit” on Page E-29.

Acquiring images of the copyboard directly by the computer

Start the reading operation of the copyboard from the computer side, and send directly to the computer the image data that has been read. This will allow display and printing. To make use of this function, install the supplied “PLUS Image Viewer” and “TWAIN Driver” on the computer.

Installation

1

Preparations for installation

Quit any applications that are currently running on the computer. If not, installation may not be completed properly.

2

Set the included CD-ROM in the CD-ROM drive.

The menu window appears automatically.

If the menu window does not appear automatically, open the CD-ROM folder and double-click on “autorun.exe”.

3

Select the menu and click.

- When “Image Viewer” is clicked, the TWAIN driver is installed simultaneously.
- When “TWAIN driver” is clicked, only the TWAIN driver is installed.

Note

- *When using a TWAIN compatible application, these operations are possible even if only the TWAIN driver is installed.*

• The installer will start up when clicked.

Follow the messages displayed on the screen to install.

Once installation is completed, “Restart computer now?” appears. Click “Yes” to restart the computer.

This completes the installation.

Acquire copyboard images on the computer using the PLUS Image Viewer

Preparation and Check

1. Has the installation of the USB driver on the supplied CD-ROM been completed? (Page E-25)
2. Has the connection been made between the copyboard’s PC dedicated USB port and the USB port of the computer? (Page E-25, step 2)
3. Has installation of the aforementioned “TWAIN Driver” and “PLUS Image Viewer” been completed?

1

Starting the “PLUS Image Viewer”

On the computer, choose “Start” → “Programs” → “PLUS Copyboard” → “PLUS Image Viewer”.

The PLUS Image Viewer starts up.

- For details on using Image Viewer, see “PLUS Image Viewer Help”.

2

Click “TWAIN source” on the “File” menu.

3

Select “PLUS Copyboard M-11”, then click “Select”.

4

Click “TWAIN Acquire” on the “File” menu.

The control panel will be displayed on the screen.

If the control panel does not appear, check the connection of the USB cable and the copyboard’s status.

Continued on next page

Supplied Software Setup Guide

5

Click the “Save to PC” button of the on-screen control panel.

The sheet of the copyboard will scroll and reading will begin.

When reading is completed, the image of the sheet surface that has been read will be displayed on the computer screen.

Notice

- Do not drag the on-screen control panel during the reading process or operate other software because this might interfere with the reading process.

6

Click the “Close” button of the on-screen control panel to exit.

The control panel will disappear and the reading process will be completed.

When disconnecting the USB cable, first perform the USB disconnection procedure at the computer side. See “Disconnecting USB Connections with the Main Unit” on Page E-29.

Using the Setup Utility

The copyboard's operating environment can be changed using the Setup Utility.

Content: "binding margin" setting, time setting, enabling/disabling of timestamp, printing/saving mode, paper mode, and image aspect ratio

Installation

1

Preparations for installation

Quit any applications that are currently running on the computer. If not, installation may not be completed properly.

2

Set the included CD-ROM in the CD-ROM drive.

The menu window appears automatically.

If the menu window does not appear automatically, open the CD-ROM folder and double-click on “autorun.exe”.

3

Click “Setup Utility” on the menu

The installer is launched. Follow the messages displayed on the screen to install.

The installation will finish, and if “Restart the computer now” is displayed, select “Yes” to restart the computer.

This completes the installation.

Starting the Setup Utility

Preparation and Check

1. Has the installation of the USB driver on the supplied CD-ROM been completed? (Page E-25)
2. Has the connection been made between the copyboard's PC dedicated USB port and the USB port of the computer? (Page E-25, step 2)
3. Has installation of the aforementioned “Setup Utility” been completed? Once installed, there is no need to install it again.

1

Starting the Setup Utility

On the computer, choose “Start” → “Programs” → “PLUS Copyboard” → “M-11 Setup Utility”.

The Setup Utility starts up.

*For details on using the Setup Utility, see “M-11 Setup Utility Help”.

Perform the USB device disconnection procedure at the computer side before disconnecting the USB cable. See “Disconnecting USB Connections with the Main Unit” on Page E-29.

Disconnecting USB Connections with the Main Unit

Perform the USB device disconnection procedure at the computer side before disconnecting the USB cable between the main unit and the computer.

The disconnection operation will differ depending on the operating system (OS) of the computer. See the computer instruction manual or on-screen Help for details.

-
- 1 Click the [Hardware Removal] icon  that is displayed in the task tray.**
Click "Stop M-11 USB Device".
 - 2 Click [OK] when "The 'PLUS Copyboard M-11 USB Device' device can now safely removed from the System" is displayed.**
(When using Windows XP, [OK] does not appear on the message screen. Simply disconnect.)
-

Note

- *The USB drive may not be disconnected properly, for example if the computer is in the process of checking the status of peripherals.*
-

Uninstalling the software







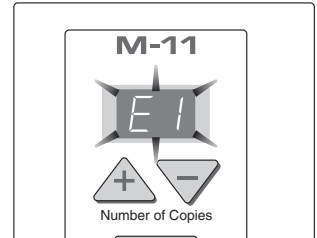

If you no longer need software you have installed, use the procedure below to uninstall it.

-
- 1 Select "Start" → "Control Panel".**
The control panel window is displayed.
 - 2 Double-click "Add/delete programs or applications" (the name differs according to the operating system).**
The "Program add/delete properties" window appears.
From the list, select the program you want to delete (uninstall), then click "Change/Delete". The add/delete wizard window appears.
 - 3 Select the "Remove" button on the wizard window, then click "Next".**
Uninstalling starts.
* Use "Add/delete applications" for Windows XP.
-

Meaning of Error Messages

If any of the following flashing indications appear in the display window of the control panel, please check the matters described below. The flashing will continue for 5 seconds. Error messages will flash for 5 seconds; however, error displays of "E4" and "E5" will be lit steadily after the flashing stops.



Error Display Number	Problem and Solution	
 Printer not connected No printing paper Printer problem	<ul style="list-style-type: none"> Is the printer cable connected? Is power being supplied to the printer? When the printer uses an AC power adapter, is the cable disconnected somewhere? 	<ul style="list-style-type: none"> Connect the printer properly and switch on the printer power.
	<ul style="list-style-type: none"> Has paper been set in the printer? 	<ul style="list-style-type: none"> Insert A4 or Letter size paper into the printer.
	<ul style="list-style-type: none"> Is the printer error indicator flashing (or lit)? 	<ul style="list-style-type: none"> Read the printer instruction manual.
 USB Memory not recognized	<ul style="list-style-type: none"> Is the USB memory unformatted. 	<ul style="list-style-type: none"> This unit supports the FAT 12/16 and FAT 32 formats. Perform the formatting with the personal computer.
	<ul style="list-style-type: none"> Is a USB memory that is not supported by the copyboard being used? 	<ul style="list-style-type: none"> Please see our home page for information about USB memories that can be used with the copyboard. (http://www.plus-vision.com)
	<ul style="list-style-type: none"> Is the USB memory device plugged in fully? Is the memory card damaged? 	<ul style="list-style-type: none"> Please check the operation with a personal computer.
 USB Memory storage problem	<ul style="list-style-type: none"> An error occurred during USB memory storage. 	<ul style="list-style-type: none"> Please perform USB memory storage again. Do not insert or remove the USB memory card during processing.
 Reading problem	<ul style="list-style-type: none"> There is a lighting fault of the reading light source, or a read signal error. 	<ul style="list-style-type: none"> Unplug the power plug from the power outlet and then plug it in again.
 System error	<ul style="list-style-type: none"> There is a memory or internal fault. 	<ul style="list-style-type: none"> Unplug the power plug from the power outlet and then plug it in again.
 USB memory not connected When the "Usb" letter display is flowing...Warning that disconnection of USB memory has been forgotten 	<ul style="list-style-type: none"> USB memory device is not plugged into the main unit. 	<ul style="list-style-type: none"> Plug the USB memory device into the USB port.
	<ul style="list-style-type: none"> Did you press the ON/Standby (⏻) button while the USB memory device was plugged into the main unit? 	<ul style="list-style-type: none"> A USB memory device is plugged into the main unit. When the USB memory device is disconnected, the power will be switched off and the unit will enter the standby mode.
 USB Memory is full	<ul style="list-style-type: none"> There is no available space. 	<ul style="list-style-type: none"> Please delete unnecessary data using a personal computer or this machine (See Page E-21).
 An unsupported printer is connected	<ul style="list-style-type: none"> A printer that is not supported by the copyboard has been connected. 	<ul style="list-style-type: none"> Press the ON/Standby (⏻) button and switch off the power. When a record is required, switch on the power and save to USB memory.

If the problem persists, please contact your nearby PLUS Vision sales office, dealer, or store.

Troubleshooting

Please check the following matters before making a request for servicing.

	Condition	Please Check
Copyboard Related	Pressing the ON/Standby  button does not switch on the power.	<ul style="list-style-type: none"> Check whether the cable of the AC power adapter is disconnected from the DC connector of the copyboard or the wall outlet.
	Writing on the sheet is not erased with the eraser.	<ul style="list-style-type: none"> Was a marker other than a special marker used? (Moisten a cloth with water or neutral detergent, wring well, and wipe carefully.)
	Portions of writing or lines are not printed or stored in memory.	<ul style="list-style-type: none"> Portions of blurred characters or thin lines may not be printed or stored in USB memory. Change Density setting to "Dark".
	The copy is soiled. (The image data is dirty at the time of printing, USB memory storage, or personal computer saving.)	<ul style="list-style-type: none"> Is there a lot of marker refuse adhering to the sheet? (When soiled, moisten a soft cloth with water, wring well, and wipe the sheet in a stroking manner.)
	The ruled line of the sheet appears on the print or in the file of the USB memory, or the black ink mixes into other color in the case of Color Mode.	<ul style="list-style-type: none"> Check the density indicator, and select standard density if the setting is darker.
	When the copyboard and PC are connected, the supplied utility program does not operate after installation of the USB driver	<ul style="list-style-type: none"> Has the USB driver in the CD-ROM been properly registered in the device manager? (An exclamation mark (!) will be affixed if it has not been registered.) (If not registered, delete the USB driver and reinstall it.)
	When the copyboard and PC are connected, the PC does not recognize the copyboard	<ul style="list-style-type: none"> Check whether the copyboard is in an operable condition, and whether the USB cable is connected properly. Is the copyboard connected to the PC via a USB hub? (Connect the copyboard directly to the USB port of the PC.)

* If the problem persists, please contact your nearby PLUS Vision sales office, dealer, or store.

	Condition	Please Check
Printer Related	A press of the Print  button does not result in printing.	<ul style="list-style-type: none"> Check that the power cable of the printer and the printer cable are securely connected. Check that the printer power indicator is lit. Check that the error indicators of the copyboard and the printer are not lit. If the error indicator of the copyboard is flashing, please see Page E-30. (Please see the printer instruction manual for information about printer errors.)
	The paper feed is abnormal.	<ul style="list-style-type: none"> Possible causes include damp paper, overly thin or thick paper, only one sheet of paper is set, and a curved setting of the paper. (Please see the instruction manual for your printer.)
	An altered color is printed, not the specified color.	<ul style="list-style-type: none"> Please replace the print cartridges with new ones.
	There is no printing.	<ul style="list-style-type: none"> Check that the print cartridge is properly set. Check that the print cartridge is not plugged.

* Please see your printer manual for information about printing problems, printer maintenance, and details related to printing.

Specifications

BOARD TYPE (Model name)		Standard (M-11S)	Wide (M-11W)
Form	Installation method	Self-standing (T-shaped legs), or wall mounting	
	External dimensions (T-shaped legs*1)	W1470 × D700 × H1970 (Max) mm	W1970 × D700 × H1970 (Max) mm
	Main unit weight	26.0 kg (excluding printer)	30.0 kg (excluding printer)
	T-shaped legs weight	9.6 kg	
BOARD	Panel Size	H920 × W1300 mm	H920 × W1800 mm
	Effective reading size	H900 × W1280 mm	H900 × W1780 mm
	Number of Pages	2	
	Paging	Endless in one direction (Horizontal scrolling)	
	Drive method	Sheet movement	
	Reading method	CCD sensor reduction optical system	
	Reading illumination light source	RGB LED	
	Reading resolution	Main scanning direction (vertical sheet surface) 2.4 dots/mm (60 dpi or equivalent) Sub scanning direction (horizontal sheet surface) 2.4 dots/mm (60 dpi or equivalent)	
	Reading time	Black & white: approx. 15 s Color: approx. 23 s	Black & white: approx. 20 s Color: approx. 31 s
	Memory	Type	USB Flash memory*2
Compatible FAT types		FAT 12, 16, 32	
File format		PNG format*3 and associated HTML format	
Interface		USB1.1 or USB2.0 full-speed mode*4	
Control panel	Control buttons	ON/Standby, +, -, Print, Save, Reprint, Color, Density, Feed/Stop	
	LED Indicators	Density, Color	
	Display	7-Segment (Page, Error#),	
Added functions	Clock	Used for the timestamp and for file dating properties (Includes backup battery for when there is a loss of power)	
	PC connection	Transfer of sheet surface image data via USB (TWAIN supported)	
Power supply	AC power adapter	Input : AC100–240V/50–60 Hz, Max 1.5 A Output : DC 24 V, 2.71 A	
Operating conditions	Temperature:	10–35°C	
	Humidity:	30–85% (No condensation)	
Recording Section	Printer interface	USB1.1 or USB2.0 full-speed mode*4 compliant printers are supported	
Miscellaneous	Ruled lines	50 mm cross-ruled squares	
	Miscellaneous	Special markers (black, red, blue, and green)	

Remarks

*1: The height is adjustable at 1770, 1870 and 1970 mm.

*2: A USB memory is not included in the package.

*3: The PNG format can be opened with Internet Explorer 6.0 or above, or with a Web browser that supports PNG file access.

*4: Not correspond High-speed mode.

- Please note that for quality improvement purposes, specifications and design are subject to change without prior notice.
- Depending on the product name, the printer and T-shaped legs (stand) will be available separately.

Appendix

Connections between copyboard and printer

The installation method at the printer side will differ depending on your printer.

- (1) Connect the copyboard's printer connector with the printer's USB connector using the supplied USB cable.
- (2) Use the power cable supplied with the printer to connect the AC INPUT power connector of the printer with the (100 V AC) wall outlet.

This completes the connection of the printer.

Now make the power connections of the copyboard. See "AC Power Adapter Connections" on Page E-13.

When connections are completed, fasten the cable with the supplied cable clips.

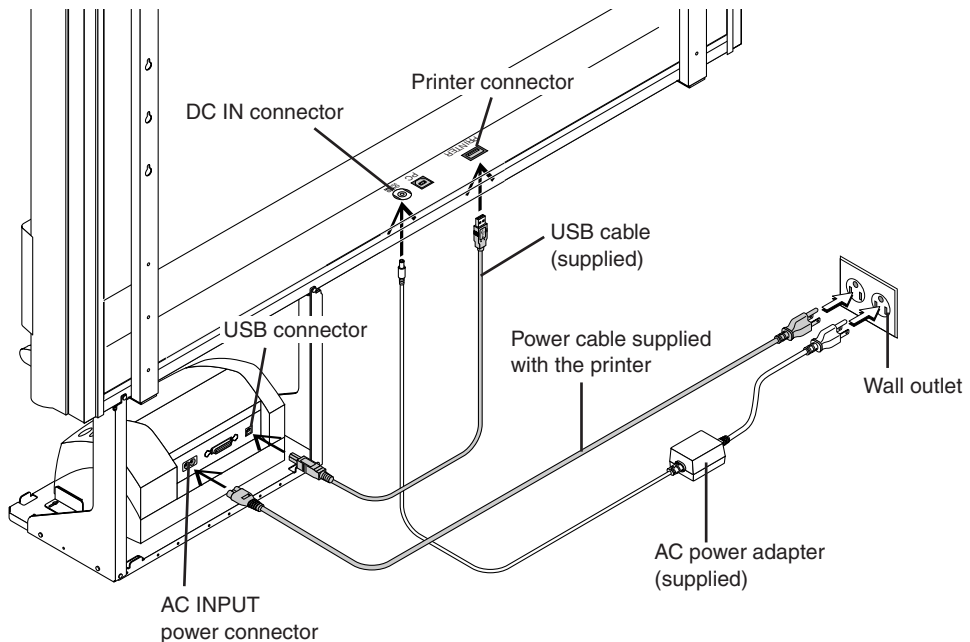

* The printer is an option.

* Appearance of printer is for illustration purposes.

Changing the Height of the Unit

This is the height adjustment when setting up the copyboard on the optional stand. The stand height can be adjusted to 3 levels in 100 mm units.

CAUTION

Please have 2 or more persons hold the unit. If the unit is dropped or falls over, this could cause unexpected injury.

Please lock the casters by pushing the lower portion of the lock button.

(1) **Disconnect the power cable and all other connection lines.**

(2) **Take out the printer and remove the printer tray.**

Please loosen the printer guide fastening screws before removing the printer.

Remove the two M4 screws from bottom side of the printer stand and the other two from the rear surface.

(3) **Remove the two lock knobs (located at the left and right sides).**

(4) **Change the hole position of the rear frames.**

The copyboard will disengage from the hooks when it is lifted up about 1 cm.

Fully hook the (2 left and right) installation holes of the rear frames onto the hooks of the stand.

If a stay (for preventing shaking) is mounted on the printer stand, insert the stay in its original position.

(5) **Attach the lock knobs to the 2 locations (left and right) and tighten to the rear frames.**

(6) **Return to original by following the steps in reverse.**

