

Indoff
www.ahutton.com
(860)632-2026

EXTRUSION IDENTIFICATION CHART

Please Note:

**When estimating shipping costs, be aware that anything
OVER 8 feet in length must ship by Common Carrier.
Orders UNDER 8 feet may ship by UPS.**

Anything over 15 feet in length will incur an additional charge of \$57.

Add .20 per linear foot for cut pieces. No discounts for partial pieces. Customer can choose to ship or have us discard remainders. For example, if a part comes in 24' standard, and a customer cuts a piece to 8', he / she is still responsible for the cost of the full 24' piece and must decide what to do with the 16' remainder.

Packaging charges will vary.

As a general rule, the more you order of standard sizes, the more you can save on shipping and cutting charges!

**For a quote, please contact Jennifer Hemstock
Email: ann@ahutton.com
Phone: 860-632-2026 ext. 118**

Be sure to have your part number, quantities and shipping number available.

EXTRUSION IDENTIFICATION CHART

all are Clear anodized Aluminum unless another color or material is noted

J-Trim

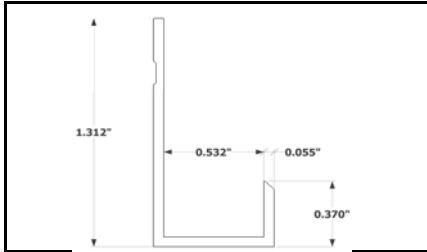

Description: #66K 1/2" J-Trim with Narrow 3/8" Face
Use for: To frame 1/2" materials
Related to:
Accessories for:

Item Number	Price per ft	per piece	Lgth	Wt/FT
Trim#66K-24	\$1.36	\$33.09	24' 4"	0.144

UPS can only ship 8'2" max and there is a cut noted above plus costs to ship larger pieces
****This is an extrusion only. This is not a kit. Ends are square cut.

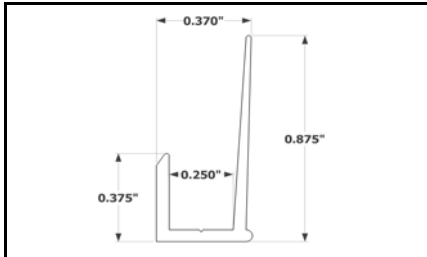

Description: #1132 1/4" J - Trim with 3/8" face
Use for: to trim 1/4" materials
Related to:
Accessories for:

Item Number	Price per ft	per piece	Lgth	Wt/FT
Trim#1132-24	\$ 1.40		24" 4"	0.074

****This is an extrusion only. This is not a kit. Ends are square cut.

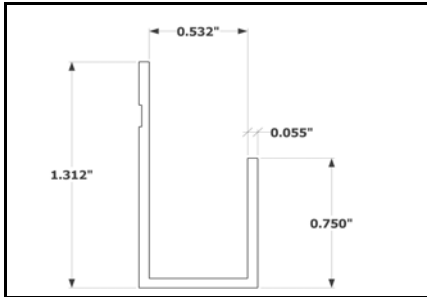

Description: #1321 1/2" J - Trim with 3/4" face
Use for:
Related to:
Accessories for:

Item Number	Price per ft	per piece	Lgth	Wt/FT
Trim#1321-14	\$1.44		14' 4"	0.168
Trim#1321-16	\$1.44		16' 4"	0.169
Trim#1321-20	\$1.44		20' 4"	0.169
Trim#1321-24	\$1.44		24' 4"	0.169

****This is an extrusion only. This is not a kit. Ends are square cut.

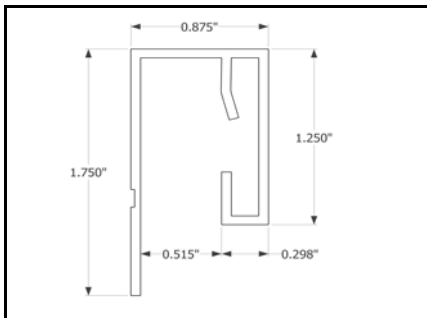

Description: Deluxe J - Trim 16' 4"
Use for:
Related to:
Accessories for:

Item Number	Price per ft	per piece	Lgth	Wt/FT
Trim#2055-16	\$3.46		16' 4"	0.35
Trim#2055-20	\$3.46		20' 4"	
Trim#2055-24	\$3.46		24' 4"	

****This is an extrusion only. This is not a kit. Ends are square cut.

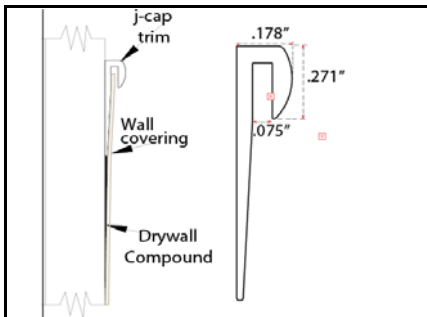

Description: J-Cap for Dry erase Wallpaper FOB PA
Use for:
Related to: MarkaWall Dry Erase Wallpaper
Accessories for:

Item Number	Price per ft	per piece	Lgth	Wt/FT
J-Cap		\$16.80	12 ft	

\$4.00 per cut and be ordered as 4', 8' or uncut at 12' Must buy full 12 ft
****This is an extrusion only. This is not a kit. Ends are square cut.

Ohio Aluminim IND-1 framing

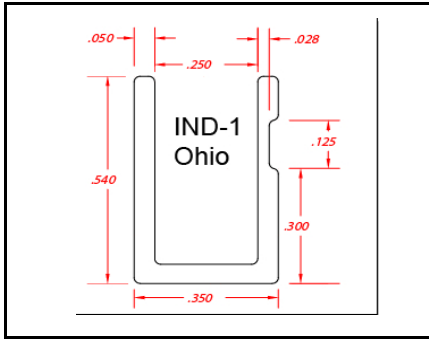

Description: **Ind-1 Framing for 1/4" thick Boards with 1/2" face**

Use for:
Related to:
Accessories for: For Tray use #196 Blade Tray

Item Number		Price per ft	per piece	Lgth	Wt/FT
Ind-1-67		\$0.70		67"	
Ind-1-91		\$0.70		91"	
Ind-1-106		\$0.70		106"	
Ind-1-127		\$0.70		127"	
Ind-1-146		\$0.70		146"	

FOB Zip 45241 Ohio

****This is an extrusion only. This is not a kit. Ends are square cut.

EZ-Hang-1 framing

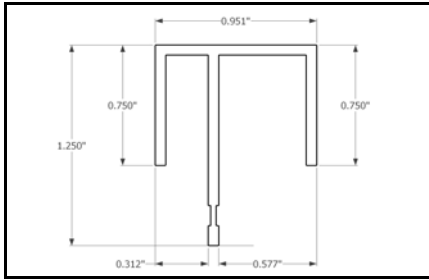

Description: **#1919 EZ - Hang Framing for 1/2" thick Boards with 3/4" face**

Use for:
Related to:
Accessories for: for tray use #2032

Item Number		Price per ft	per piece	Lgth	Wt/FT
Trim#1919-14		\$2.36		14'4"	0.257
Trim#1919-16		\$2.34		16'4"	0.257
Trim#1919-20		???		20'4"	0.257
Trim#1919-24		\$2.76		24'4"	0.257

for tray use 2032 Blade tray

****This is an extrusion only. This is not a kit. Ends are square cut.

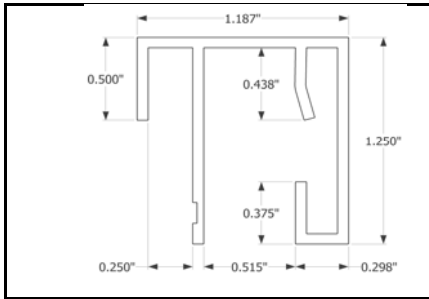

Description: **#2054 Deluxe EZ - Hang with 1.25" face**

Use for: 3-D effect on face
Related to:
Accessories for:

Item Number		Price per ft	per piece	Lgth	Wt/FT
Trim#2054-16		\$3.38		16'4"	0.368
Trim#2054-20		\$3.38		20'4"	
Trim#2054-24		\$3.38		24'4"	

****This is an extrusion only. This is not a kit. Ends are square cut

Indoff
www.ahutton.com
(860)632-2026

EZ-Hang-2 framing

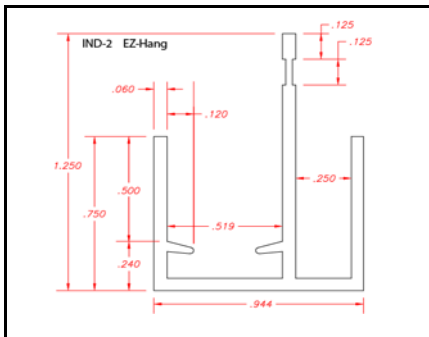

Description: **EZ - Hang-2 Framing for 1/2" thick Boards with 1/2" face**

Use for:
Related to:
Accessories for:

Item Number		Price per ft	per piece	Lgth	Wt/FT
Ind-2-67		\$1.62		67"	
Ind-2-91		\$1.62		91"	
Ind-2-106		\$1.62		106"	
Ind-2-127		\$1.62		127"	
Ind-2-146		\$1.62		146"	

for tray use 2032 Blade tray

Corner Brackets available for \$.68 each Force fit style - no rivets needed

Force fit corner Bracket available for joining sections

****This is an extrusion only. This is not a kit. Ends are square cut.

Mullions 1/4" and 1/2"

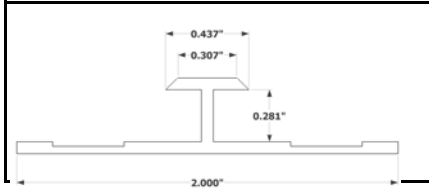

Description: 1/4" H - Bar with 1/2" face

Use for:
Related to:
Accessories for:

Item Number		Price per ft	per piece	Lgth	Wt/FT
Mullion#128K		\$2.46		24'4"	0.182

****This is an extrusion only. This is not a kit. Ends are square cut.

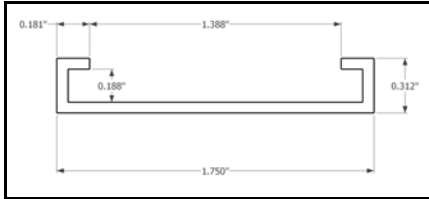

Description: #489 Snap-On H-Bar

Use for: Frame out dry erase wallpaper
Related to:
Accessories for: need # ????? Wall mount clip every 16"

Item Number		Price per ft	per piece	Lgth	Wt/FT
MULLION#489		\$1.96		25'	0.185

requires snap to attach to wall used to frame things like dry erase wallpaper

****This is an extrusion only. This is not a kit. Ends are square cut.

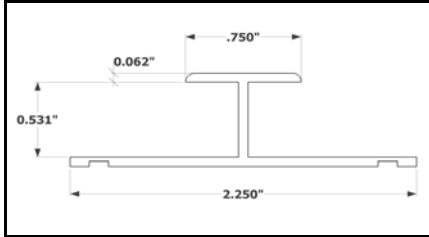

Description: #2037 1/2" H - Bar with 3/4" face

Use for:
Related to:
Accessories for:

Item Number		Price per ft	per piece	Lgth	Wt/FT
Mullion#2037		\$2.20		24'4"	0.25

****This is an extrusion only. This is not a kit. Ends are square cut.

Indoff
www.ahutton.com
(860)632-2026

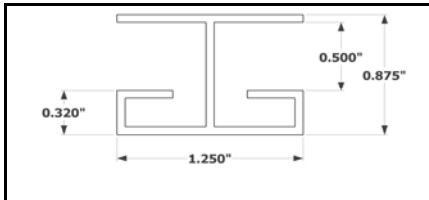

Description: #481 Deluxe H-Bar with 1.25" face

Use for:
Related to:
Accessories for:

Item Number		Price per ft	per piece	Lgth	Wt/FT
Mullion#481		\$2.58		24'4"	0.292

****This is an extrusion only. This is not a kit. Ends are square cut.

Chalktrays Box Style

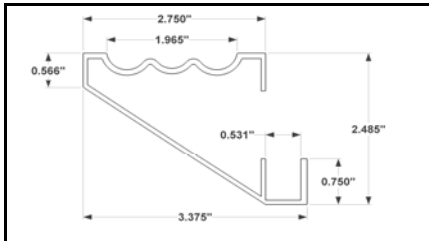

Description: #37 Factory Box Chalktray to use with 1/2" backing

Use for:
Related to:
Accessories for:

Item Number		Price per ft	per piece	Lgth	Wt/FT
Chlktry#37-16		\$6.52		16'	0.829
Chlktry#37-20		\$6.52		20'	
Chlktry#37-24		\$6.52		24'	

****This is an extrusion only. This is not a kit. Ends are square cut.

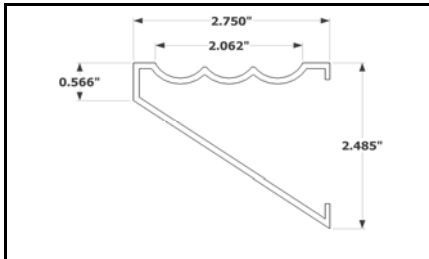

Description: #439 Flush Mount Box Chalktray

Use for:
Related to: Perfect to go under dry erase wallpaper
Accessories for: Cast end caps and wall clips

Item Number		Price per ft	per piece	Lgth	Wt/FT
Chlktry#439		\$5.94		8'	0.753
Chlktry#439		\$5.94		24'	0.753

Accessories Cast End Cap Set \$18 per set
Clips for 439 Tray need one every 16' \$0.36

****This is an extrusion only. This is not a kit. Ends are square cut.



Description: Cast End Cap for Box Chalktray

Use for:
Related to: Perfect to go under dry erase wallpaper
Accessories for: Cast end caps and wall clips

Item Number		\$ per pair		Lgth	Wt/set
EC w/o Leg	for \$39 Only	\$18.00	only pairs		
EC with Leg	for #984.#26,37	\$12.00	only pairs		

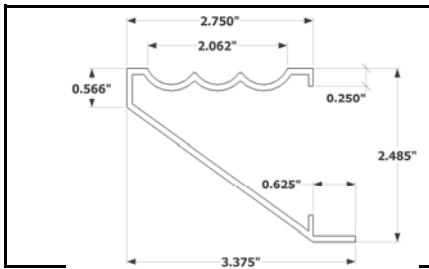

Description: **#984 Snap-On Box Chalktray with leg**
 Use for:
 Related to:
 Accessories for:

Item Number	Price per ft	per piece	Lgth	Wt/FT
Chlktry#984-16	\$4.68		16'	0.835
Chlktry#984-20	\$4.68		20'	
Chlktry#984-24	\$4.68		24'	

Cast End Cap Set \$12 per pair with return leg

****This is an extrusion only. This is not a kit. Ends are square cut.

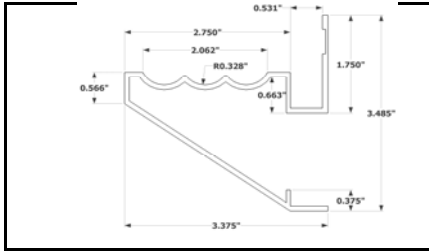

Description: **#26 Field Box Chalktray 16'**
 Use for:
 Related to:
 Accessories for:

Item Number	Price per ft	per piece	Lgth	Wt/FT
Chlktry#2544-16	\$8.10		16'	0.946
Chlktry#2544-20	\$8.10		20'	
Chlktry#2544-24	\$8.10		24'	

****This is an extrusion only. This is not a kit. Ends are square cut.

Chalktrays Blade Style

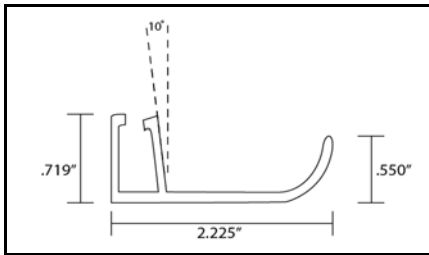

Description: **Plastic Tray for Ohio Aluminum Frame -Snap-On**
 Use for: Ohio Aluminum Frame
 Related to:
 Accessories for:

Item Number	Price per ft	per piece	Lgth	Wt/FT
PVC-Snap-Grey	we stock 10' pcs	\$3.00		
PVC-Snap-Black	we stock 10' pcs	\$3.00		

****This is an extrusion only. This is not a kit. Ends are square cut.

Indoff
www.ahutton.com
 (860)632-2026

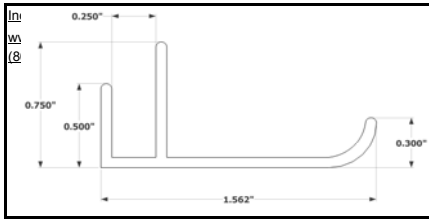

Description: **1/4\"/>
 Use for:
 Related to:
 Accessories for:**

Item Number	Price per ft	per piece	Lgth	Wt/FT
Chlktry#196	\$3.08		16'4"	0.209

****This is an extrusion only. This is not a kit. Ends are square cut.

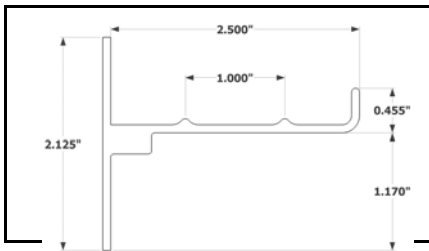

Description: **#467 Flat Faced Blade Chalktray**
 Use for:
 Related to:
 Accessories for:

Item Number	Price per ft	per piece	Lgth	Wt/FT
Chlktry#467	\$4.68		24'4"	0.59

****This is an extrusion only. This is not a kit. Ends are square cut.

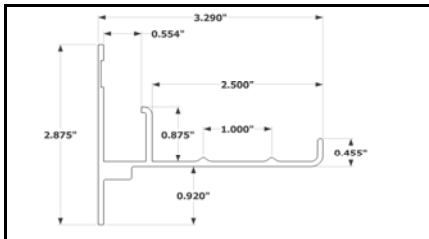

Description: **#1272 #10 Field Flat Blade Chalktray**
 Use for:
 Related to:
 Accessories for:

Item Number	Price per ft	per piece	Lgth	Wt/FT
Chlktry#1272R-16	\$5.88		16'4"	0.806
Chlktry#1272R-20	\$5.88		20'4"	
Chlktry#1272R-24	\$5.88		24'4"	

****This is an extrusion only. This is not a kit. Ends are square cut.

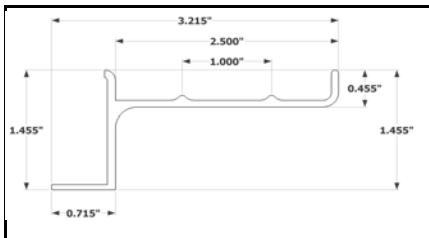

Description: **#2031 #20 Screw-On Flat Blade Chalktray with leg**
 Use for:
 Related to:
 Accessories for:

Item Number	Price per ft	per piece	Lgth	Wt/FT
Chlktry#2031-16	\$4.32		16'4"	0.508
Chlktry#2031-20	\$4.32		20'4"	
Chlktry#2031-24	\$4.32		24'4"	

****This is an extrusion only. This is not a kit. Ends are square cut.

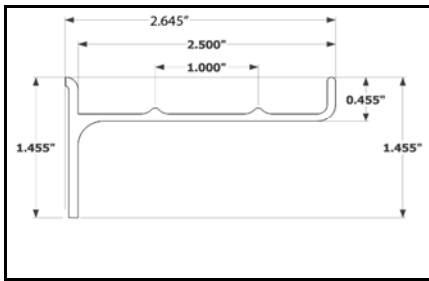

Description: #2031 without .715 leg - Only Sold with Magnet on back

Use for:

Related to: only available with magnet back

Accessories for:

Item Number		per piece	Lgth	Wt/FT
Chlktry#2031-10"	With Magnet	\$13.00	10"	
Chlktry#2031-12"	With Magnet	\$15.60	12"	
Chlktry#2031-18"	With Magnet	\$23.40	18"	
Chlktry#2031-24"	With Magnet	\$31.20	24"	

Prices include rounding of all corners in piece lengths above - nice looking
Due to the lip at top - it will not be flush to wall without magnet. Sold only with Magnet

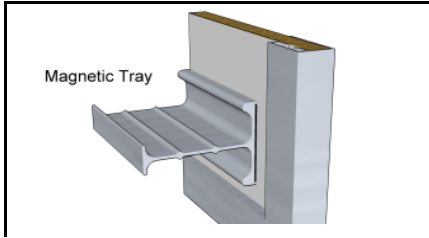

Description: #49 Flat Blade Tray with a very strong magnet

Use for:

Related to: Use on any steel surface

Prices include rounding of all corners in piece lengths above - nice looking

Item Number		\$ per piece	\$ per piece
Chlktry#49 w/Magnet		\$16.00 10"	\$38.40 24"
Chlktry#49 w/Magnet		\$19.20 12"	\$57.60 36"
Chlktry#49 w/Magnet		\$22.40 14"	\$76.80 48"
Chlktry#49 w/Magnet		\$25.60 16"	\$153.6 96"
Chlktry#49 w/Magnet		\$28.80 18"	

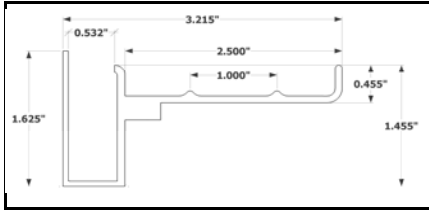

Description: #2032 EZ - Hang Flat Blade Chalktray

Use for: tray with EZ-hang trim #1919

Related to:

Accessories for:

Item Number		Price per ft	per piece	Lgth	Wt/FT
Chlktry#2032-16		\$5.40		16'4"	0.706
Chlktry#2032-20		\$5.40		20'4"	
Chlktry#2032-24		\$5.40		24'4"	

****This is an extrusion only. This is not a kit. Ends are square cut.

Maprail Section

Note cork must be ordered separately

[see Maprails to get w/ Cork](#)



Description: #5 2" Flush Mount Maprail

Use for:

Related to: see Maprail Page for Cut Cork Strips and other endcaps

Accessories for: All Encaps \$.50 Each

Item Number		Price per ft	per piece	Lgth	Wt/FT
Maprail#5		\$1.60		24'4"	0.214

****This is an extrusion only. This is not a kit. Ends are square cut.

Cork Must be ordered separately. This is Extrusion only.

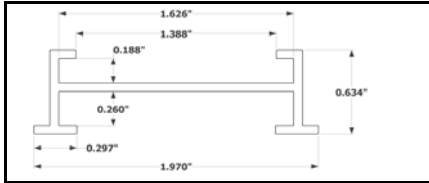

Description: #441 2" Wall Mount / Flat Maprail

Use for:

Related to: see Maprail Page for Cut Cork Strips and other endcaps

Accessories for: All Encaps \$.50 Each

Item Number		Price per ft	per piece	Lgth	Wt/FT
Maprail#441-16		\$2.34		16'4"	0.268
Maprail#441-20		\$2.34		20'4"	
Maprail#441-24		\$2.34		24'4"	

****This is an extrusion only. This is not a kit. Ends are square cut.

Cork Must be ordered separately. This is Extrusion only.

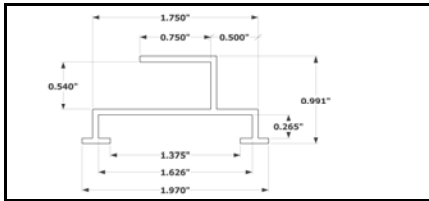

Description: #442 2" J Maprail

Use for:

Related to: see Maprail Page for Cut Cork Strips and other endcaps

Accessories for: All Encaps \$.50 Each

Item Number		Price per ft	per piece	Lgth	Wt/FT
Maprail#442-16		\$2.96		16'4"	0.315
Maprail#442-20		\$2.96		20'4"	
Maprail#442-24		\$2.96		24'4"	

****This is an extrusion only. This is not a kit. Ends are square cut.

Cork Must be ordered separately. This is Extrusion only.

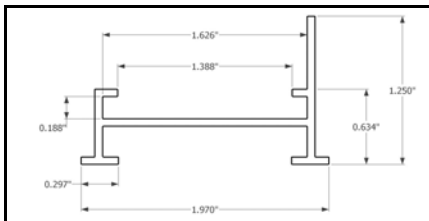

Description: #443 2" Snap-On Extended Maprail

Use for:

Related to: see Maprail Page for Cut Cork Strips and other endcaps

Accessories for: All Encaps \$.50 Each

Item Number		Price per ft	per piece	Lgth	Wt/FT
Maprail#443-17		\$3.10		17'	0.311
Maprail#443-21		\$3.10		21'	
Maprail#443-25		\$3.10		25'	

****This is an extrusion only. This is not a kit. Ends are square cut.

Cork Must be ordered separately. This is Extrusion only.

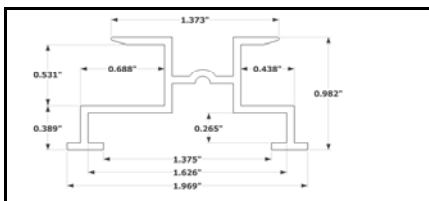

Description: #1273 2" Field Appld. #11 Maprail

Use for:

Related to: see Maprail Page for Cut Cork Strips and other endcaps

Accessories for: All Encaps \$.50 Each

Item Number		Price per ft	per piece	Lgth	Wt/FT
Maprail#1273-16		\$3.36		16'4"	0.356
Maprail#1273-20		\$3.36		20'4"	
Maprail#1273-24		\$3.36		24'4"	

****This is an extrusion only. This is not a kit. Ends are square cut.

Cork Must be ordered separately. This is Extrusion only.

Indoff
www.ahutton.com
(860)632-2026

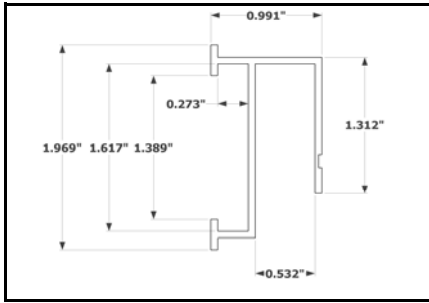

Description: #1442 2" J Maprail Flat Top

Use for:
 Related to: see Maprail Page for Cut Cork Strips and other endcaps
 Accessories for: All Encaps \$.50 Each

Item Number	Price per ft	per piece	Lgth	Wt/FT
Maprail#1442-16	\$3.30		16'4"	0.347
Maprail#1442-20	\$3.30		20'4"	
Maprail#1442-24	\$3.30		24'4"	

****This is an extrusion only. This is not a kit. Ends are square cut.
 Cork Must be ordered separately. This is Extrusion only.

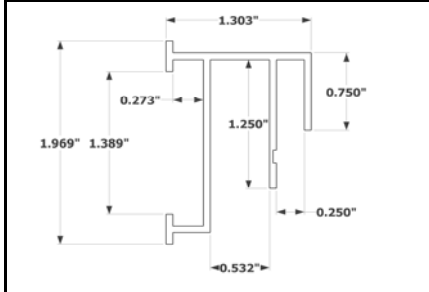

Description: #1442 EZ-Hang Maprail

Use for:
 Related to: see Maprail Page for Cut Cork Strips and other endcaps
 Accessories for: All Encaps \$.50 Each

Item Number	Price per ft	per piece	Lgth	Wt/FT
Maprail#1443-16	\$3.34		16'4"	0.421
Maprail#1443-20	\$3.34		20'4"	
Maprail#1443-24	\$3.34		24'4"	

****This is an extrusion only. This is not a kit. Ends are square cut.
 Cork Must be ordered separately. This is Extrusion only.

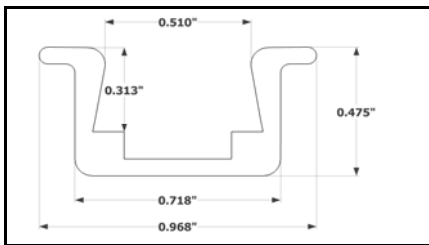

Description: #1477 1" Flat Mount Maprail

Use for:
 Related to: see Maprail Page for Cut Cork Strips and other endcaps
 Accessories for: All Encaps \$.50 Each

Item Number	Price per ft	per piece	Lgth	Wt/FT
Maprail#1477-16	\$1.44		16'4"	0.165
Maprail#1477-20	\$1.44		20'4"	
Maprail#1477-24	\$1.44		24'4"	

****This is an extrusion only. This is not a kit. Ends are square cut.
 Cork Must be ordered separately. This is Extrusion only.

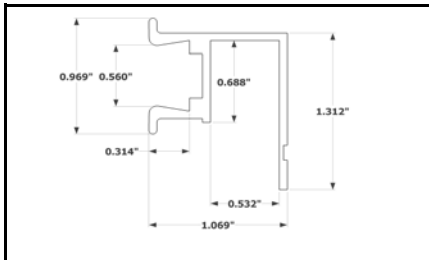

Description: #1478 1" J - Maprail

Use for:
 Related to: see Maprail Page for Cut Cork Strips and other endcaps
 Accessories for: All Encaps \$.50 Each

Item Number	Price per ft	per piece	Lgth	Wt/FT
Maprail#1478-16	\$2.30		16'4"	0.304
Maprail#1478-20	\$2.30		20'4"	
Maprail#1478-24	\$2.30		24'4"	

****This is an extrusion only. This is not a kit. Ends are square cut.
 Cork Must be ordered separately. This is Extrusion only.

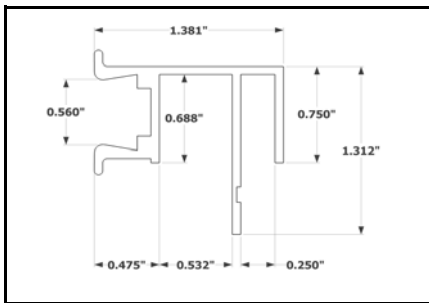

Description: 1" EZ - Hang Maprail

Use for:
 Related to: see Maprail Page for Cut Cork Strips and other endcaps
 Accessories for: All Encaps \$.50 Each

Item Number	Price per ft	per piece	Lgth	Wt/FT
Maprail#1479-16	\$2.90		16'4"	0.375
Maprail#1479-20	\$2.90		20'4"	
Maprail#1479-24	\$2.90		24'4"	

****This is an extrusion only. This is not a kit. Ends are square cut.
 Cork Must be ordered separately. This is Extrusion only.

Miscellaneous

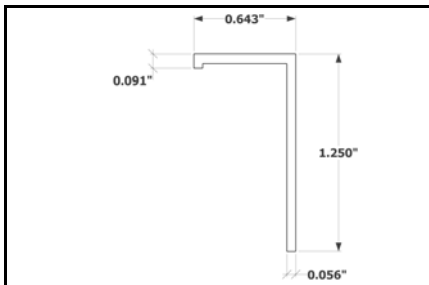

Description: #1840 Endstock & Doorjamb Angle

Use for:
 Related to:
 Accessories for:

Item Number	Price per ft	per piece	Lgth	Wt/FT
Trim#1840	\$1.68		25'	0.127
Trim#1840-BR	Call		25'	0.127

****This is an extrusion only. This is not a kit. Ends are square cut.

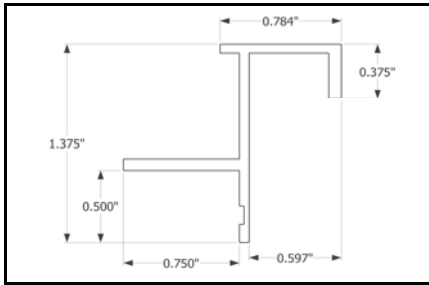

Description: #1944 Shadow Trim

Use for:
 Related to:
 Accessories for:

Item Number		Price per ft	per piece	Lgth	Wt/FT
Trim#1944-16		\$2.34		16'4"	0.254
Trim#1944-20		\$2.34		20'4"	0.254
Trim#1944-24		\$2.34		24'4"	0.254

****This is an extrusion only. This is not a kit. Ends are square cut.

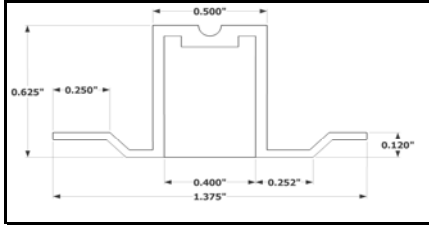

Description: GROUNDS FOR SNAP-ON TRIM

Use for:
 Related to:
 Accessories for:

Item Number		Price per ft	per piece	Lgth	Wt/FT
GROUND-AL-.5				12'	0.154

****This is an extrusion only. This is not a kit. Ends are square cut.

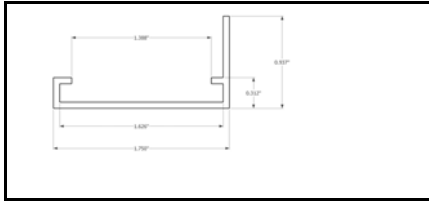

Description: #444 Snap-On Trim

Use for:
 Related to:
 Accessories for:

Item Number		Price per ft	per piece	Lgth	Wt/FT
Trim#444-17		\$2.08		17'	0.232
Trim#444-21		\$2.08		21'	
Trim#444-25		\$2.08		25'	

****This is an extrusion only. This is not a kit. Ends are square cut.

Indoff
www.ahutton.com
 (860)632-2026